

# INSTALLATION INSTRUCTIONS

## Elite 8mm Deluxe Quadrant

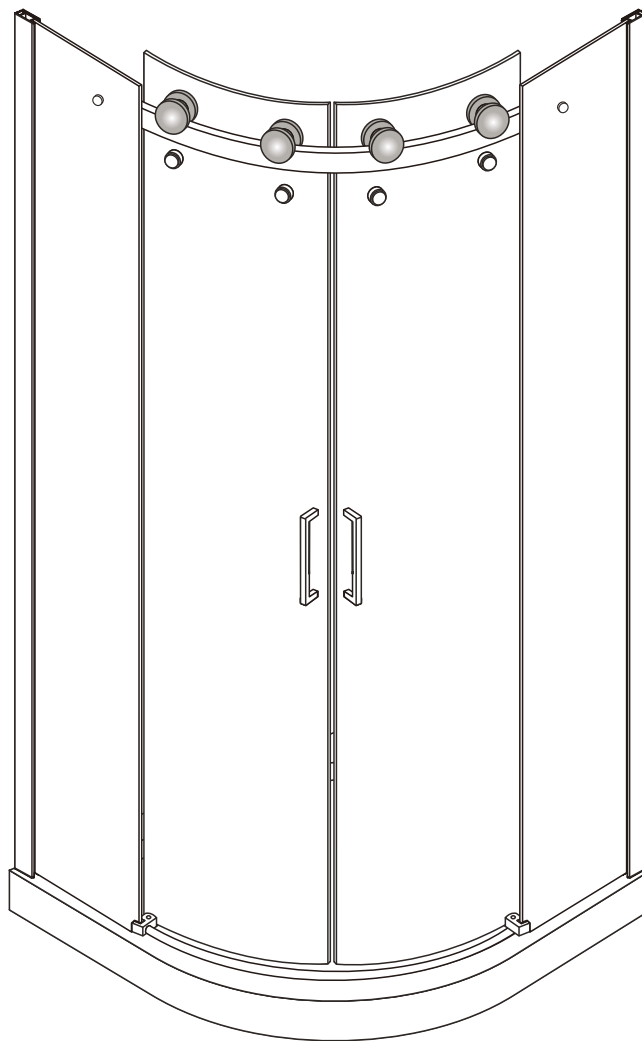

Note :If installing on a tray, follow correct method of installation by installing the tray and tile down onto this



## ◆ General Information

Please inspect the product immediately upon receipt for transit damage, missing packs/parts or manufacturing fault. Damage reported later cannot be accepted. Please handle the product with care avoiding knocks and shock loading to all sides and edges of the glass.

### **Notes: Safety glass can not be re-worked.**

Please read these instructions carefully before start of installation.

Special care should be taken when drilling walls to avoid hidden pipes or electrical cables.

Note: This product is heavy and may require two people to install.

## Aftercare instructions

After use, your shower should be cleaned with soap and water. This is particularly important in hard water districts where insoluble lime salts may be deposited and allowed to build up.

Cleaners of a gritty or abrasive nature should not be used. Care should be taken to avoid contact with strong chemicals such as organic solvents and strippers.

Glass cleaners can be used but with caution, if in doubt contact the manufacturer of the cleaner in question.

Please keep these instructions for aftercare and customer service details.

---



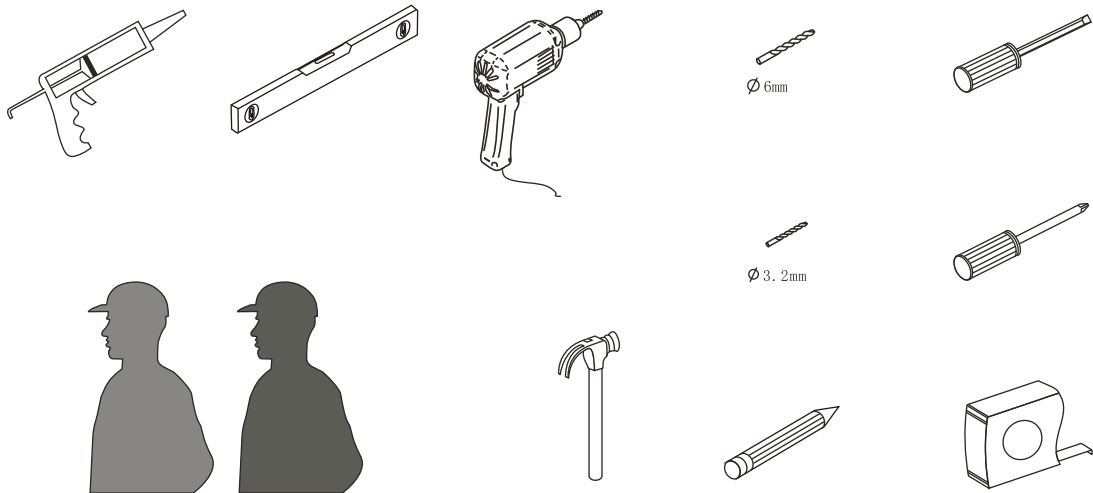













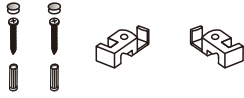





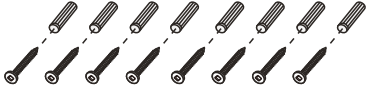

## Tools Required

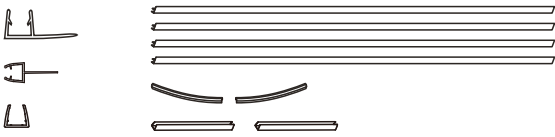

**This product is heavy and may require two people to install.**

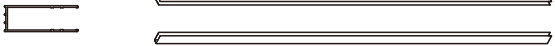

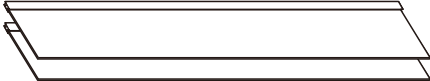
# ◆ Box Contents

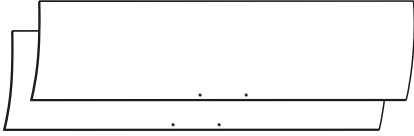
<p>[1] 1xHorizontal Rails 5xFixing Part 4xScrews M4x12. 1xFlat Screw M4x12. 5xScrew Cover Cap .</p>		
<p>[2] 1xInstallation Instruction.</p>		
<p>[3] 2xHandle Set.</p>		
<p>[4] 2xClips. 2xScrews M4x35. 2xWallPlugs. 2xScrew Cover Caps.</p>		
<p>[5] 2xFixing Part 4xAnti-collision Component</p>		
<p>[6] 2xWallConnectors. 4xTop Rollers .</p>		
<p>[7] 8xWallPlugs. 8xScrews M4x35.</p>		
<p>[8] 6xScrews M4x10. 6xScrew Cover Caps.</p>		
<p>[9] 8xWater Deflectors.</p>		
<p>[10] 1xAluminum Seal .</p>		
<p>[11] 2xWallPosts .</p>		
<p>[12] 2xFixed Panels .</p>		
<p>[13] 2xDoor Panels.</p>		

# ◆ Assembly Drawing

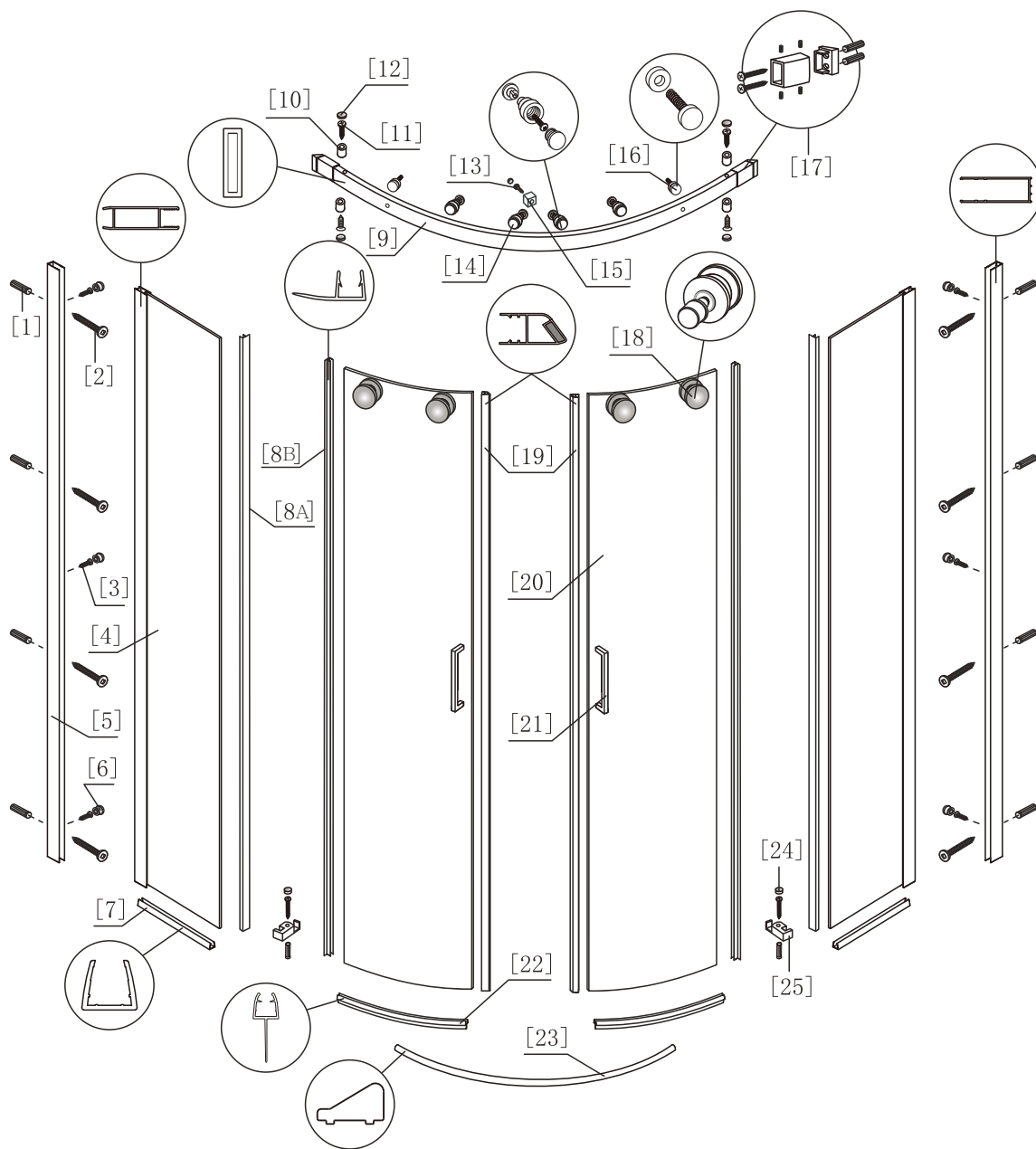

- [1] 10xWallPlugs
- [2] 10xScrews M4x35
- [3] 6xScrews M4x10
- [4] 2xFixedPanels
- [5] 2xWallPosts
- [6] 6xScrew Cover Caps
- [7] 2xWater Deflectors
- [8A] 2xWater Deflectors
- [8B] 2xWater Deflectors
- [9] 1xTop Horizontal Rail
- [10] 4xFixing Part
- [11] 4xScrews M4x12
- [12] 5xScrew Cover Caps

- [13] 1xFlat Screw M4x12
- [14] 4xAnti-collision Components
- [15] 1xFixing Part
- [16] 2xFixing Part
- [17] 2xWall Connectors
- [18] 4xTop Rollers
- [19] 2xMagnetic Seal
- [20] 2xDoor Panels
- [21] 2xHandle Sets
- [22] 2xWater Deflectors
- [23] 1xAluminum Seal
- [24] 2xScrew Cover Caps
- [25] 2xClips

**Part 9-Top Rail Length**  
 800X800 enclosure-1243mm  
 900X900 enclosure-1490mm  
 1000X1000 enclosure-1816mm

**Part 8B-With extra 10mm longer fin**

# ◆ Installation steps:

## Step 1

Important: Please see step 4 location of glass clip to set the location of the wall channels

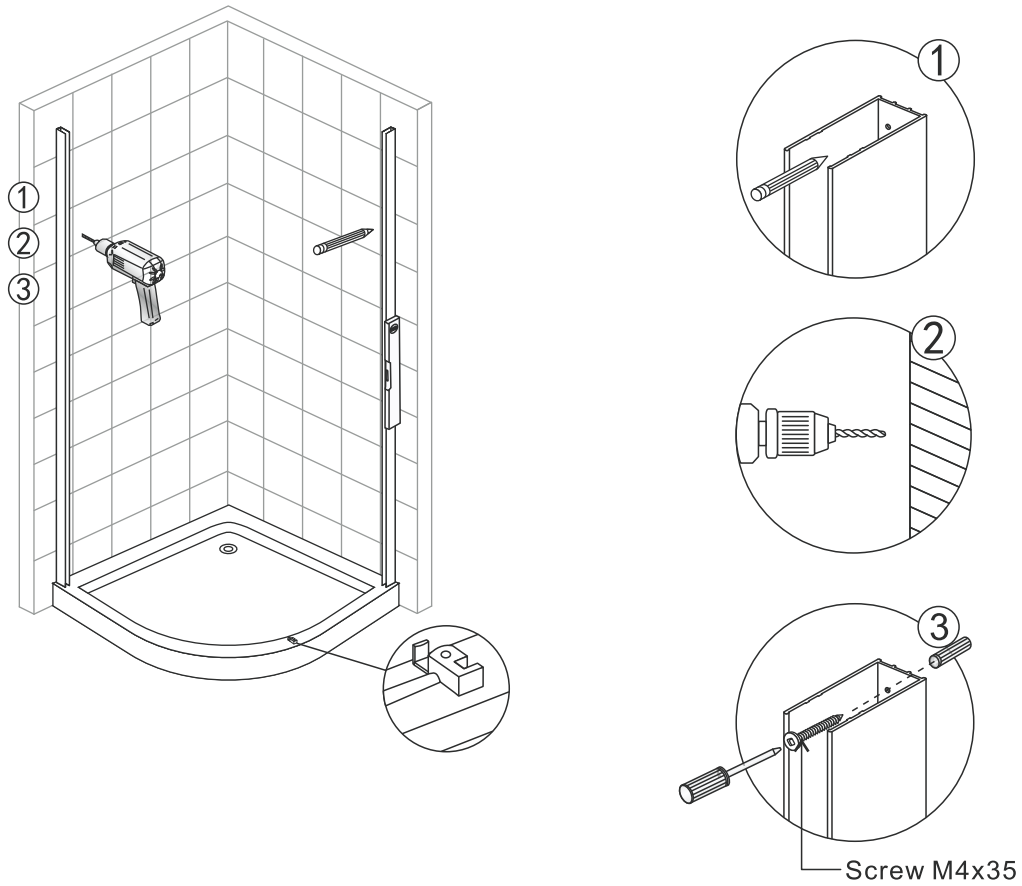

## Step 2

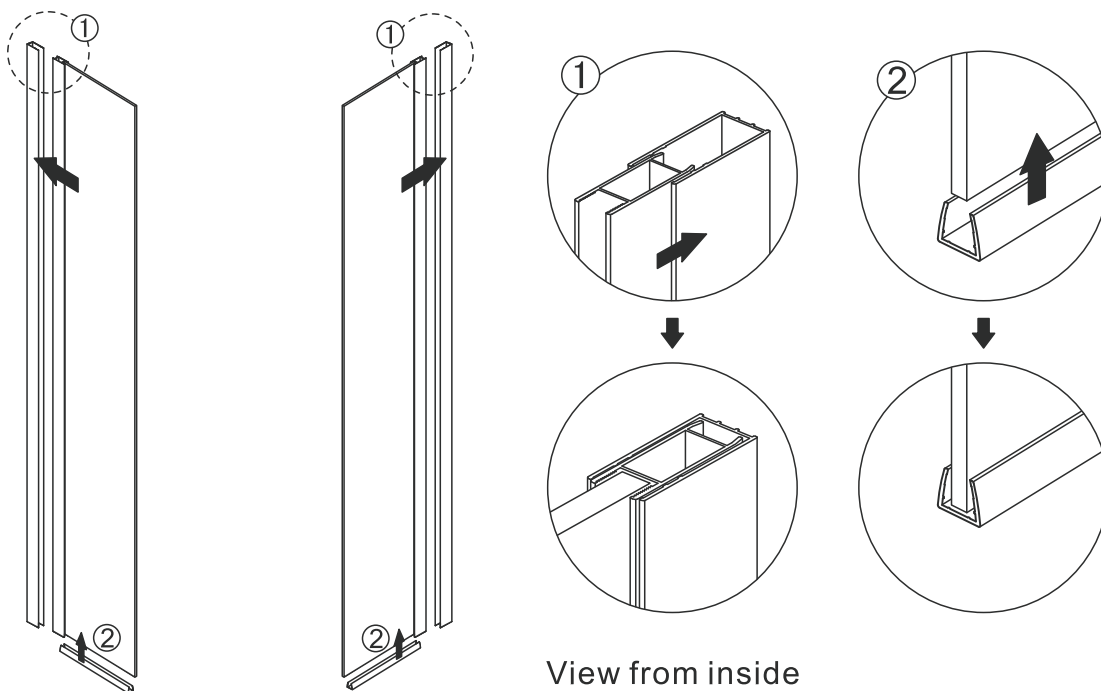

### Step 3

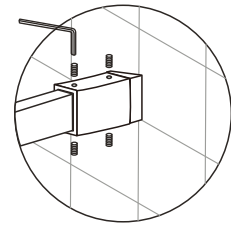
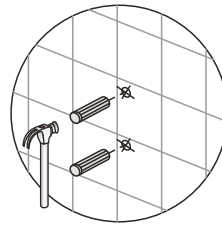
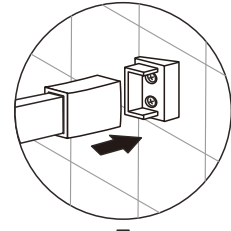
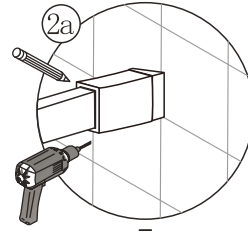
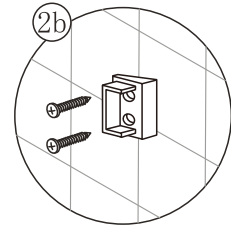
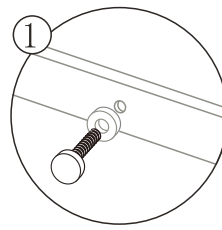
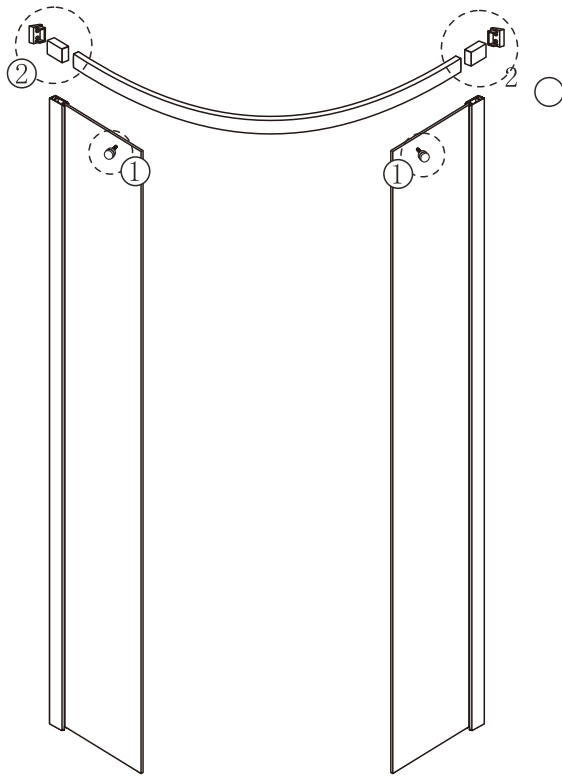

View from inside

### Step 4

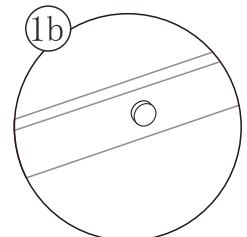
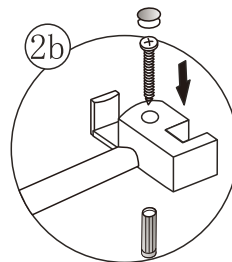
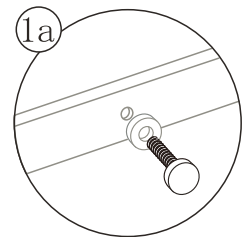
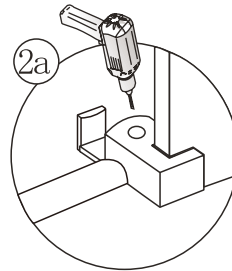
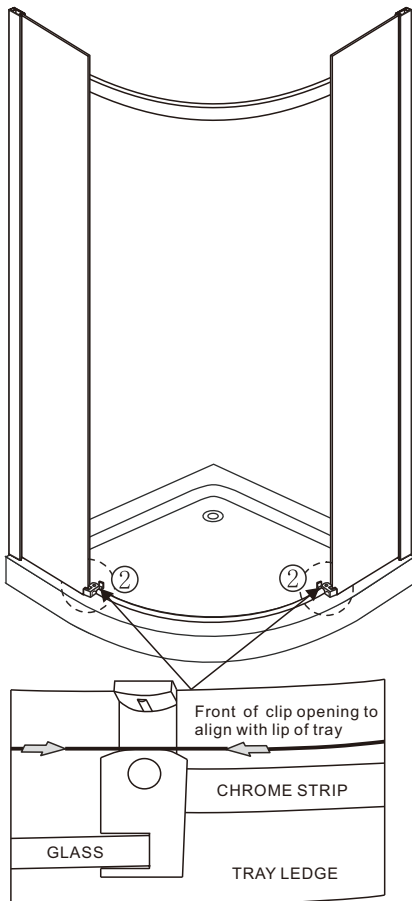

**!** If the shower enclosure installed with a tray, please make holes in the tray with  $\phi$  3mm drill and wall plugs are not required; If not, please make holes in the floor with  $\phi$  6mm drill and wall plugs are required.

## Step 5

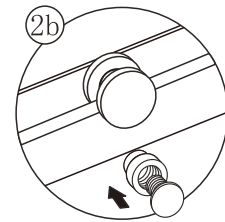
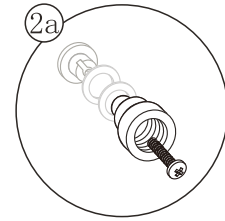
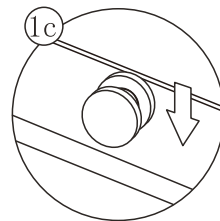
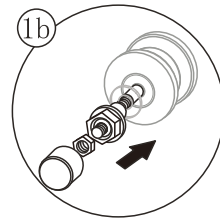
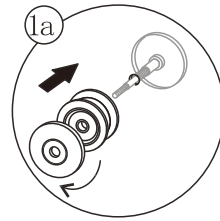
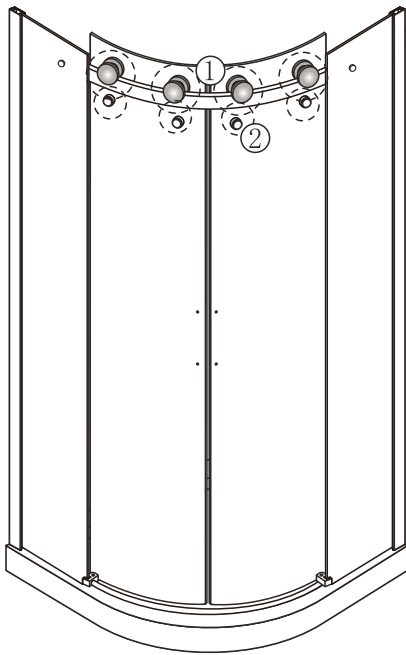

View from inside

## Step 6

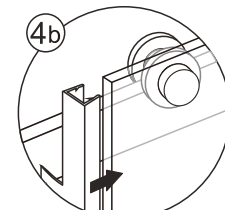
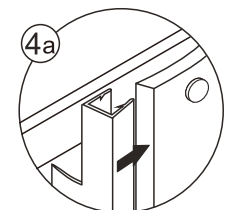
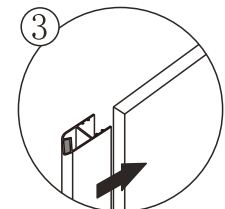
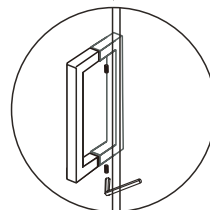
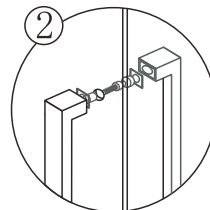
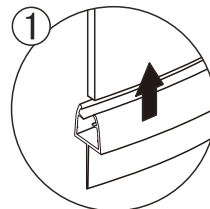
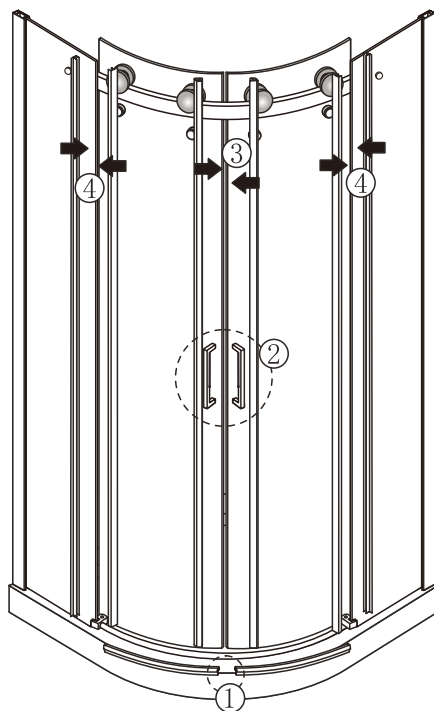

View from inside

**!** Ensure wall profiles are plumb.  
Adjust enclosure to be square and level.  
Wheels should be adjusted to square the  
doors and ensure smooth running.

# Step 7

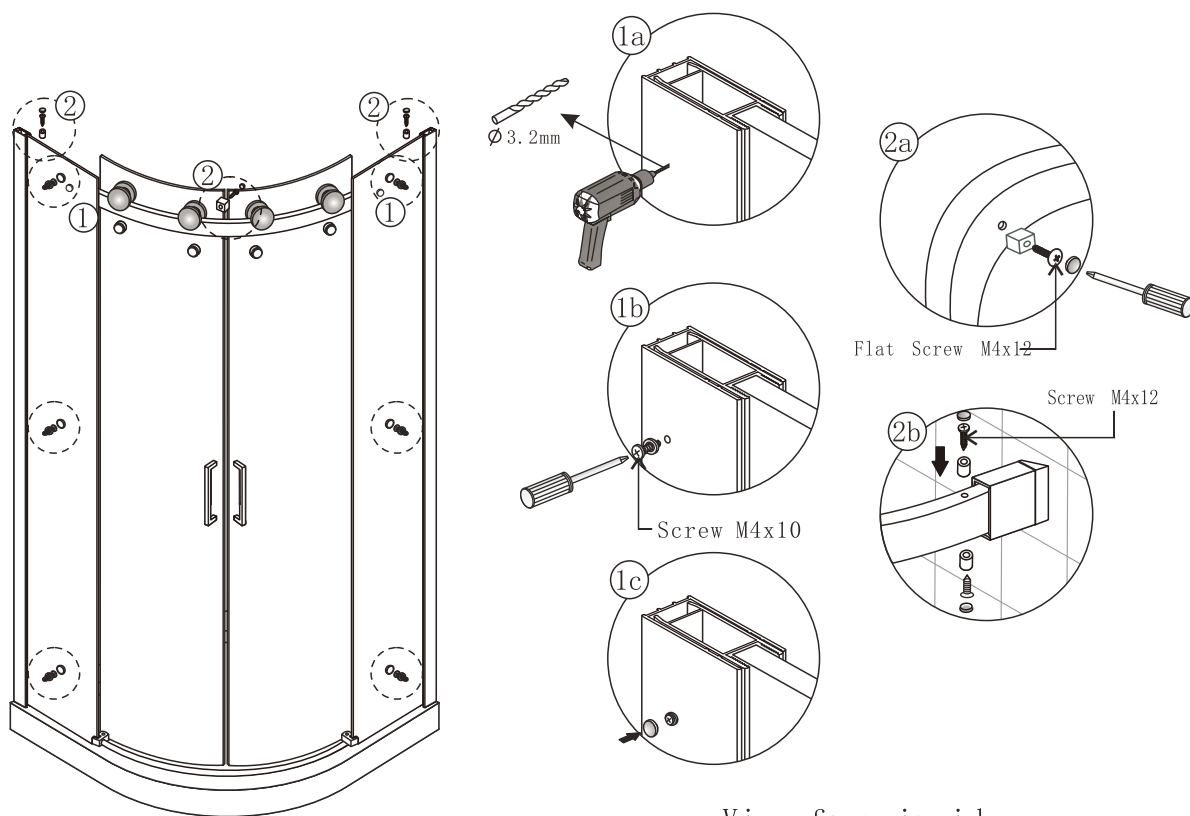

View from inside

# Step 8

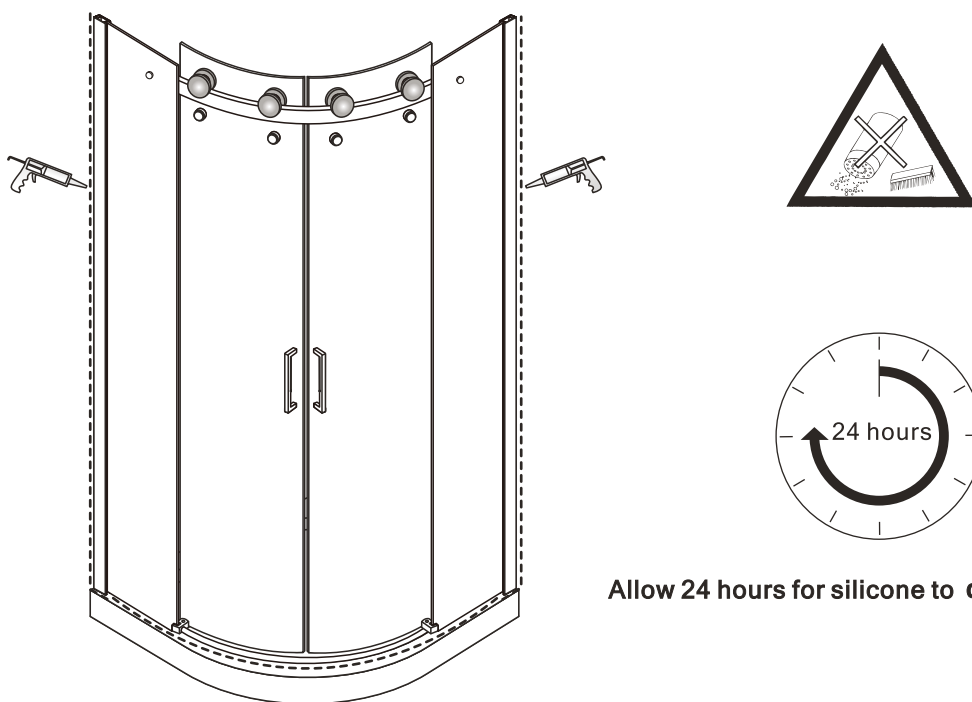

**Allow 24 hours for silicone to dry before use.**