

Shower pumps

SSL, STL, STC, SSR, STR, SSP, STP, SSN and STN

Installation and operating instructions

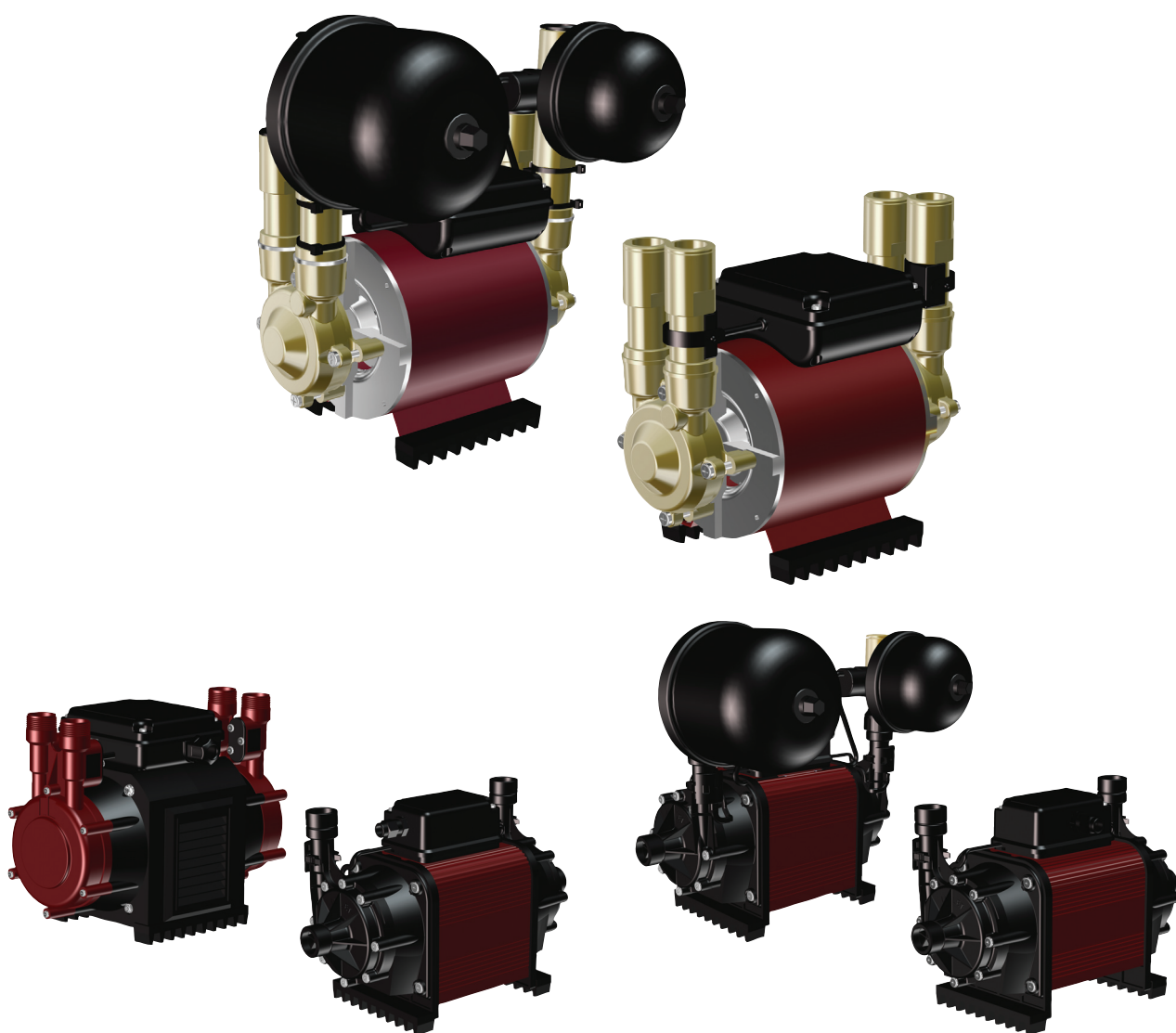

Original installation and operating instructions.

CONTENTS

	Page
1. Symbols used in this document	2
2. General description	2
2.1 Applications	2
2.2 Type key	2
3. Installation	3
3.1 Positioning the pump	3
3.2 Pipework	4
3.3 Cold-water storage tank	5
3.4 Valves and strainers	5
3.5 Connecting the pump	6
3.6 Temperature setting	7
3.7 Installation options	7
4. Electrical installation	7
4.1 1 x 230 V, 50 Hz	7
4.2 Low-voltage pumps (STL and SSL)	8
5. Startup	8
5.1 Shaft seal run-in	9
6. Universal-head pumps	9
6.1 General description	9
6.2 Dry-running protection	9
6.3 Connecting the pump	10
6.4 Operating instructions	10
6.5 Installation options	10
7. Technical data	10
8. Fault finding	11
8.1 Positive-head pumps (STP, SSP, STC, STL, SSL, STR, SSR)	11
8.2 Universal-head pumps (STN, SSN, STC CN and STL 2.0 CN)	12
9. How it works	13
9.1 Universal-head pumps	13
10. Engineer check list	13
11. Maintenance and service	13
12. Disposal	13

**Warning**

Prior to installation, read these installation and operating instructions. Installation and operation must comply with local regulations and accepted codes of good practice.

**Warning**

The use of this product requires experience with and knowledge of the product.

Persons with reduced physical, sensory or mental capabilities must not use this product, unless they are under supervision or have been instructed in the use of the product by a person responsible for their safety. Children must not use or play with this product.

1. Symbols used in this document**Warning**

If these safety instructions are not observed, it may result in personal injury.

**Warning**

If these instructions are not observed, it may lead to electric shock with consequent risk of serious personal injury or death.

**Caution**

If these safety instructions are not observed, it may result in malfunction or damage to the equipment.

**Note**

Notes or instructions that make the job easier and ensure safe operation.

2. General description

These installation and operating instructions apply to Grundfos shower pumps, types STL, SSL, STC, STR, SSR, STP, SSP, STN and SSN.

2.1 Applications

Grundfos shower pumps are suitable for pressure boosting of clean (fresh) water, without any additives, in domestic hot- and cold-water systems.

2.2 Type key

Example	S	T	P	2.0	B
S: Shower pump					
T: Twin impeller					
S: Single impeller					
P: Positive head					
N: Universal (negative) head					
L: Low voltage					
C: Centrifugal					
R: Regenerative					
Maximum head [bar]					
Material:					
B: Brass					
C: Composite					
CN: Composite, universal (negative) head					

3. Installation

The system in which this product is incorporated must be designed to meet the pumps requirements.

Symbols used in illustrations

Symbol	Description
	Cold-water storage tank
	Hot-water cylinder
	Shower pump
	Shower head
	Tap or outlet
	Hot water
	Cold water
	Mains supply pipe

Do not connect the pump directly to the water mains supply.

Caution Do not use the pump with combination boilers. Make sure that no foreign particles (such as solder and dust) are allowed to enter the pump.

Note The pump cannot operate if the level of the water in the cold-water storage tank is below the level of the pump.

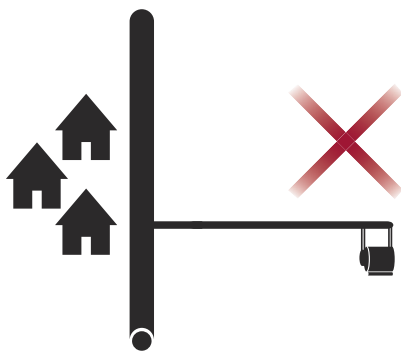

Fig. 1 Do not connect directly to the mains.

TM05 6978 0313

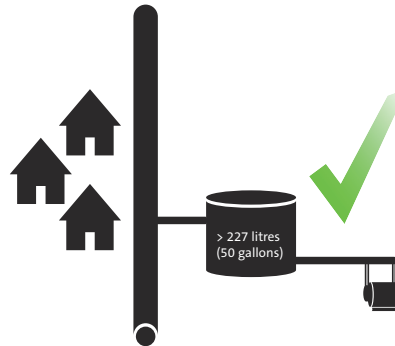

Fig. 2 Connection to mains via storage tank

TM05 6977 0313

3.1 Positioning the pump

Note Select a position for installing the pump which affords easy access for subsequent servicing and maintenance.

Keep the pump as close as possible to the source of hot and cold water.

For optimum performance, ensure the following:

- A good water flow to the pump.
- Sufficient inlet head. See table and fig. 3.
- Unrestrictive pipework, 22 mm. See fig. 4.
- Provision to prevent air locks. See fig. 4.

Place the pump in a well-ventilated location.

Type	Inlet head [m]
STP, SSP	1-20
STN, SSN	1-8
STC CN, STL-2.0 CN	2-8
STC	2-10
STL, SSL	2-10
STR, SSR	1-10

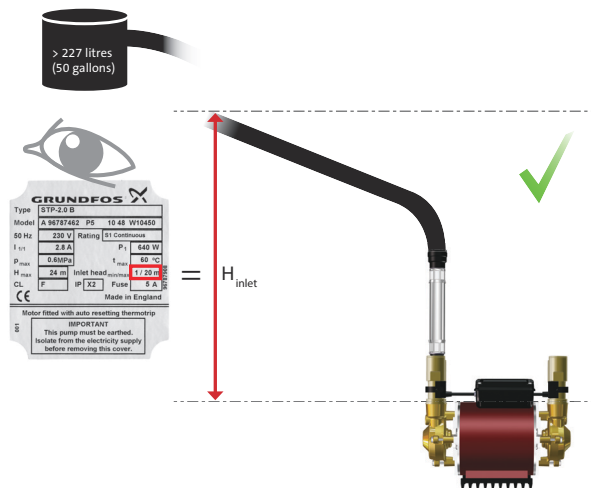

Fig. 3 Inlet head

TM05 6968 0313

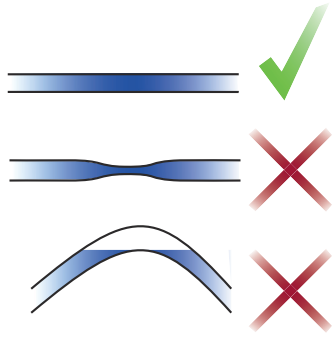

Fig. 4 Unrestricted pipework

Caution Do not cover the pump; otherwise the motor will overheat.

Caution Place the pump in a frost-free location.

Position the pump horizontally with the outlet ports vertically upwards to ensure correct operation of the flow switches.

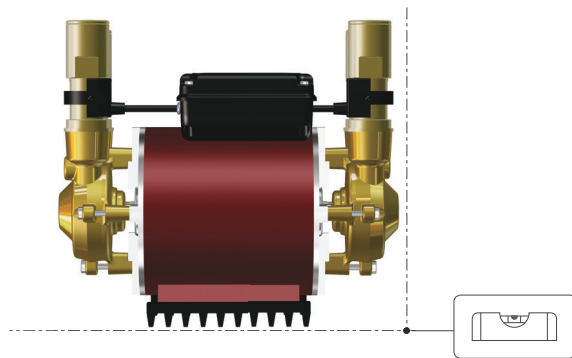

Fig. 5 Positioning the pump

Connect the pump and shower system as shown in fig. 10. There must be a minimum height between the bottom of the cold-water storage tank and the highest point of the outlet pipework or the shower outlet of at least 250 mm. See fig. 6.

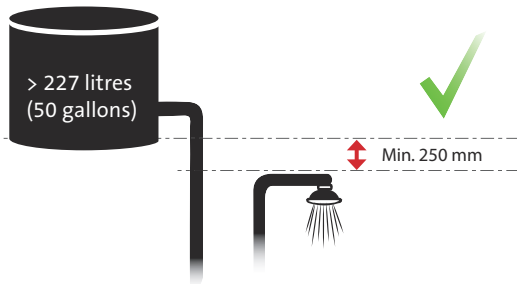

Fig. 6 Minimum height difference

Install the pump in accordance with the Water Supply (Water Fittings) regulations 1999.

Position the pump at the base of the hot-water cylinder. See fig. 7.



Fig. 7 Positioning the pump in relation to hot-water cylinder

For installation within a bathroom, locate the pump in accordance with local regulations.

Position the pump at least 0.6 metres horizontally away from or 3 metres vertically above floor from any bath, shower tray or basin.



Warning

The pump may be fitted under a bath, providing this space is only accessible through the use of a tool.

3.1.1 Foundation

Install the pump on a vibration-free foundation. In case of wooden floors use a small concrete foundation of approx. 225 x 225 mm and 40 to 50 mm thick.

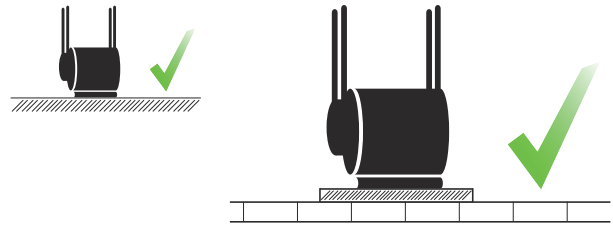

Fig. 8 Foundation

3.2 Pipework

Caution Do not allow any solder flux to come into contact with any of the plastic parts of the pumps.

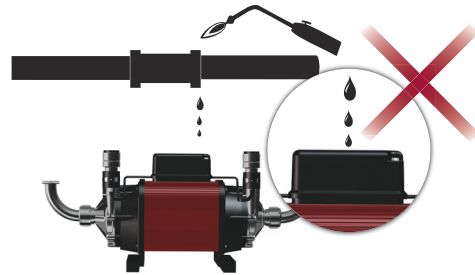

Fig. 9 Solder flux causes damage to plastic parts

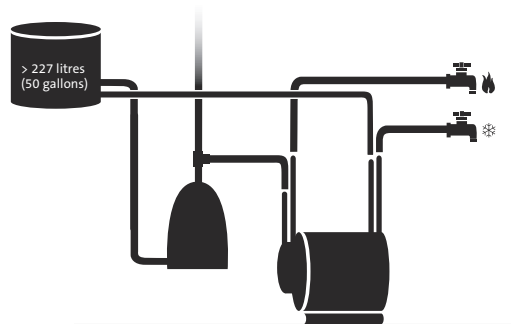

Fig. 10 Pipework connection to hot-water cylinder

Use 22 mm pipework to and from the pump.

- The expansion pipe from the hot-water cylinder should always rise in order to prevent trapped air.
- The outlet pipework from the pump to the shower valve should rise, where possible, to prevent trapped air.
- Pipework from the pump to the shower valve should go up and over, rather than under floor.
- Do not fit any other outlets in the inlet pipes to the pump. See fig. 12.
- Use dedicated supplies to hot and cold water.
- Avoid blanked-off pipes.
- Avoid restrictions in the flexible hoses.
- Secure down all pipework to minimise noise and vibration.

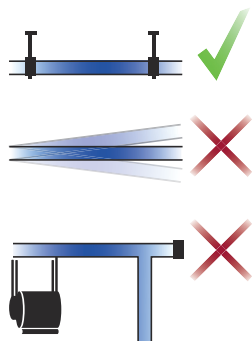

Fig. 11 Fixing the pipework

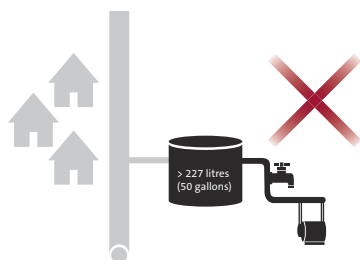

Fig. 12 Pipe installation examples

3.2.1 Hot-water cylinder connections

Caution Do not use any jointing compounds.

Connect the supply from the hot-water cylinder to the pump with a dedicated supply.

Fit a survey flange to minimise air in the hot-water supply to the pump.

Use 22 mm pipe to ensure an adequate flow to the pump.

3.2.2 Cold-water supply

Caution Do not connect the pump directly to the water mains supply.

Do not use any jointing compounds or tape.

Connect the pump with a dedicated supply using 22 mm pipe from the cold-water storage tank.

3.3 Cold-water storage tank

Position the cold-water outlet at least 25 mm lower than the supply to the hot-water cylinder to prevent the supply of hot water only.

The cold-water storage tank must be equal to or larger than 227 litres (50 gallons).

Note Do not position outlets in the cold-water storage tank directly below the inlet from the water mains supply in order to prevent air from being drawn into the pump or hot-water cylinder.

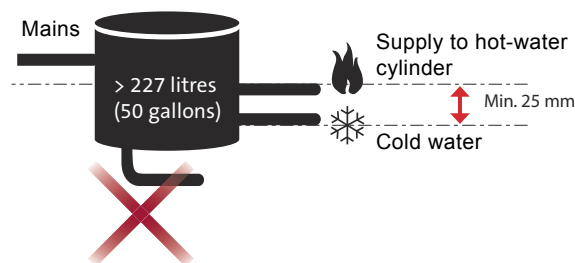

Fig. 13 Cold-water storage tank

3.4 Valves and strainers

Non-return valves

Do not fit non-return valves in the inlet pipework to the pump.

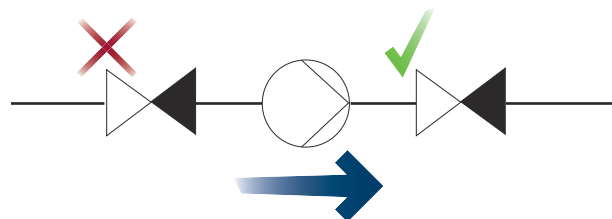

Fig. 14 Correct fitting of non-return valves

Isolating valves

Fit full-bore isolating valves in the pump inlet and outlet ports for easy installation, servicing and cleaning of strainers.

Note Isolating valves assist draining down, strainer cleaning and refilling.

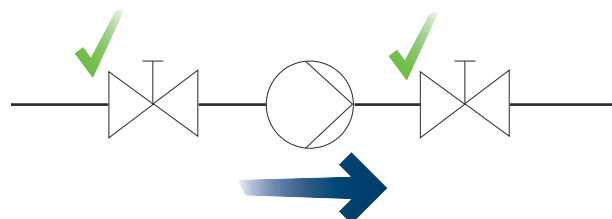

Fig. 15 Fitting of isolating valves

TM05 6966 4614

TM05 6974 0313

TM05 6972 0313

TM05 7323 1213

TM05 7323 1213

Strainers

Fit the strainers supplied with the STC, STR, SSR, STL and SSL on the inlet connections. See fig. 16.

1. Fit the strainer washer to the inlet connection.
2. Fit the plain hose washer to the outlet connection.

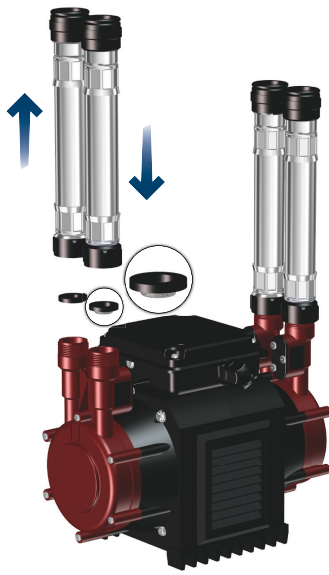

Fig. 16 Fitting the strainer washer

3. Insert the strainer basket supplied with the SSN, SSP, STN and STP in the inlet pipe.



Fig. 17 Fitting the strainer basket

3.5 Connecting the pump

Caution Do not use any jointing compounds or tape.

Use the flexible hoses supplied for connecting the pump to the pipework. Use of these hoses will ensure strain- and vibration-free watertight connections.

Caution Ensure unrestricted flow in the flexible hoses.

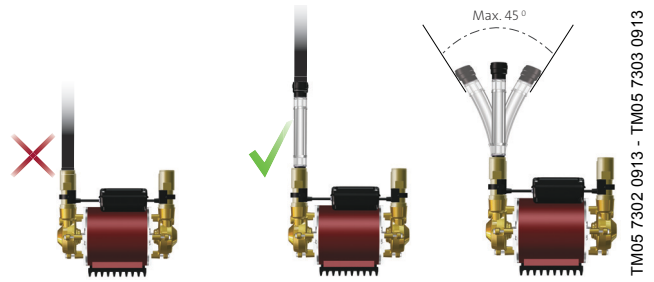

Fig. 18 Connecting the flexible hoses

Line up the pipework and fit hoses to the pump before connecting to pipes.

Caution The pump must not be subject to mechanical strain.

Plastic nuts should be finger-tight plus 1/4 turn. Re-tighten the nuts after hot water has been pumped for the first time.

TM05 7320 1113

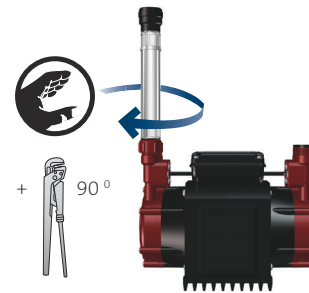

Fig. 19 Tightening the connections

Push-fit connections (SSN, SSP, STN and STP pumps)

Use the flexible hoses supplied with the pump for the pump inlet and outlet ports.

Insert the hose connection to a minimum depth of 33 mm.

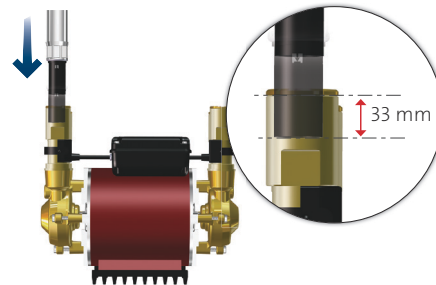

Fig. 20 Installation with push-fit connection

TM05 7321 1113

Disconnecting the hose

To disconnect the "push-fit" hose, firmly push down the retaining ring while pulling out the hose.

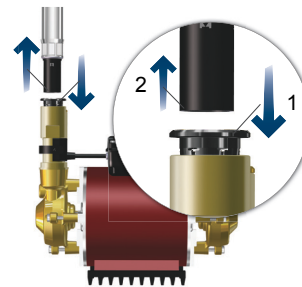

Fig. 21 Disconnecting of flexible hoses with push-fit connection

TM05 7302 0913 - TM05 7303 0913

TM05 7304 0913

TM05 7305 0913

TM05 7306 0913

3.6 Temperature setting

Maximum hot-water temperature setting must not exceed 60 °C in accordance with BS 6700:2006, to eliminate the risk of lime scale and cavitation.

3.7 Installation options

This section gives you an overview of your options during installation.

Positioning the pump

- Sufficient inlet head of at least 2 metres is required for STC, STL and SSL pumps.
- Inlet head of at least 1 m is required for SSP, STP, SSN, STN and STR pumps.
- Fit a downward loop of at least 450 mm if the pump is positioned above the hot-water cylinder. See fig. 22.



Fig. 22 Pump positioned above hot-water cylinder

Pipework

- 15-mm pipework can only be used on STC, STL, SSL, STR and SSR pumps up to 1.5 bar rated pressure.
- Where high flows are expected, we recommend 28 mm.

Electrical installation

- The low-voltage pump installation kits are supplied with 3 metres of connecting lead. The connecting leads between the pump and the isolating transformer can be extended up to about 15 metres. Use min. 1.0 mm² cable.

Flanges

- Either Surrey, York, Warix or Essex flanges can be used for the hot-water cylinder, depending on the cylinder type and installation.

4. Electrical installation

Caution

Complete all pipework before making any electrical connections.

Do not allow any water to enter into the electrical terminal box.



Warning

The electrical installation should be carried out by an authorised person in accordance with local regulations.

Check that the supply voltage and frequency correspond to the values stated on the nameplate.



Warning

During electrical installation, make sure that the power supply cannot be accidentally switched on.

Warning

The unit must be connected to a switched spur fused at 5 A (10 A on models STP 4.0 B and STN 4.0 B) with a minimum contact gap of 3 mm in all poles.



Metal pipes must be earthed by the use of earthing clamps and 4 mm² earthing wire, according to BS 951.

Warning

Connect the pump to a socket with earth connection (not for models STL and SSL).



We recommend that you fit the permanent installation with an earth leakage circuit breaker (ELCB) with a tripping current ≤ 30 mA.

4.1 1 x 230 V, 50 Hz

1. Strip off the insulation cap and the leads as specified for the switched spur.

Observe colour coding as follows:

- Brown to terminal L.
- Yellow/green to terminal E (PE). Ensure that the earth lead is at least as long as the other two leads.
- Blue to terminal N (neutral).

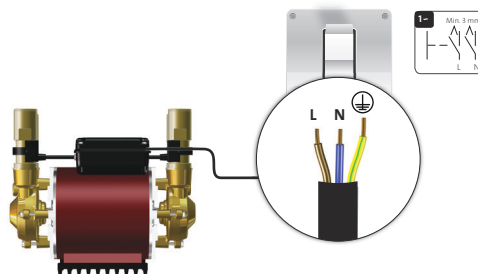

Fig. 23 Electrical connection

2. Insert the lead fully into the terminal connector and tighten the screw firmly.
3. Ensure that the connection is secure.
4. Tighten the cable restraint.

Caution

Follow the procedure for startup before switching on the power supply.

Ensure compliance with IEE regulations.



Warning

Fit the terminal box cover before you switch on the power supply.

The pump switch should be left in "on" position at all times for normal operation of the system.



Fig. 24 Electrical supply permanently on

TM05 6975 0313

TM05 7316 1013

TM05 7309 0913

4.2 Low-voltage pumps (STL and SSL)

Use the transformer supplied.

Caution Do not connect the pump directly to the mains supply.

The low-voltage pump incorporates electrical protection via a safety isolating transformer.

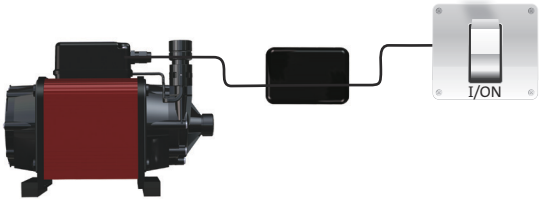

Fig. 25 Connection via transformer

Place the safety isolating transformer according to local regulations.

All transformers are fitted with auto-resetting thermal cut-outs.



Warning

Do not locate 230-240 V connections, plugs or switches within the "wet" area in accordance with IEE regulations.

Connect the low-voltage leads from the transformer to the two terminals marked "T" in the pump terminal box.

The low-voltage pump installation kits are supplied with 3 metres of connecting lead.

Observe the colour coding on the transformer primary side as follows:

- Brown to terminal L.
- Blue to terminal N.

Caution Follow the procedure for startup before switching on the power supply.

The transformer can be left permanently switched on for normal operation. Very little power is used when the pump is not running.

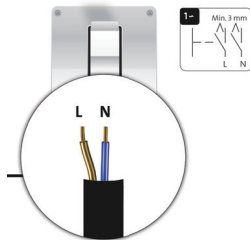

Fig. 26 Electrical connection of transformer

If the transformer or transformer cables are damaged, replace the transformer and discard the old one.

5. Startup

Caution Do not start the pump until it has been filled with liquid.



Warning

Prior to startup, flush the system through with clean water and drain to remove possible impurities.

1. Turn on the water supply. Allow the system to fill.
2. Immediately inspect for any leaks.

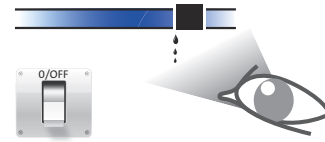

Fig. 27 Inspect for leaks before operation

3. With the pump not running, allow maximum water flow, for example remove handset from shower hose.
4. Operate maximum hot and cold flows for at least two minutes to flush out all debris. See fig. 28.

Note

STN, SSN, STC-1.5 CN, STC-2.0 CN, STL-2.0 CN: The power supply should be switched on.

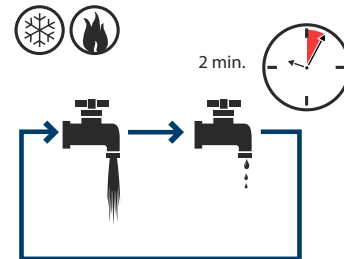

Fig. 28 Operating hot- and cold-water taps

5. Switch on the power supply, run the pump for a few minutes, switch off, drain down and clean the inlet strainers. See fig. 29.

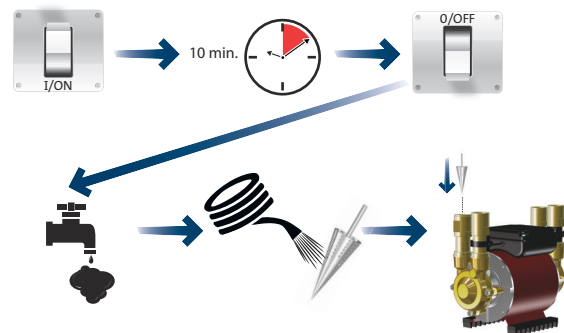

Fig. 29 Cleaning the suction strainer

For SSN, SSP, STN and STP pumps, remove the inlet hose from the pump, and the strainer basket can be removed by hand or with long-nosed pliers.

6. Replace the inlet strainers and reconnect the hoses.
7. Turn on the water supply. With the power supply off, allow maximum water flow, for example remove handset from shower hose.

Note

STN, SSN, STC-1.5 CN, STC-2.0 CN, STL-2.0 CN: The power supply should be switched on.

8. Operate maximum hot and cold flows for at least five minutes each to ensure air is thoroughly purged from the system.
9. Replace handset on shower hose.
10. Switch on the power supply.
11. Operate the pump in both full hot and cold modes for at least two minutes each while inspecting for leaks.

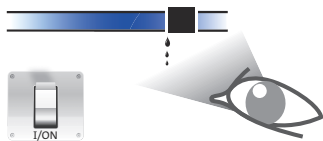

Fig. 30 Inspect for leaks after operation

12. Check that all hot-water connections are tight and not leaking, when the hot water has been run for several minutes. See fig. 30.

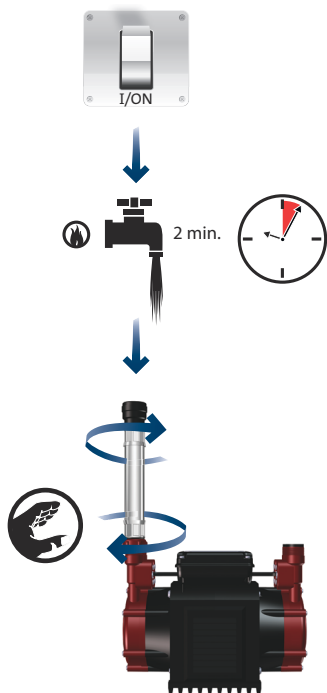

Fig. 31 Re-tighten connections after operation

The first few times the pump is used, the insulating varnish used on the pump motor may give off an odour. This is perfectly normal and will diminish with use.

Note *Run the pump for five minutes or more at least once every four weeks in order to prevent the pump from seizing up. Scale build-up can cause the pump parts to stick.*

5.1 Shaft seal run-in

The seal faces are lubricated by the pumped liquid, meaning that there may be a certain amount of leakage from the shaft seal. When the pump is started up for the first time, or when a new shaft seal is installed, a certain run-in period is required before the leakage is reduced to an acceptable level. The time required for this depends on the operating conditions, i.e. every time the operating conditions change, a new run-in period will be started. Under normal conditions, the leaking liquid will evaporate. As a result, no leakage will be detected.

6. Universal-head pumps

STN, SSN, STC-1.5 CN, STC-2.0 CN, STL 2.0 CN

6.1 General description

Automatic universal-head shower pumps are designed to operate automatically in installations where the shower outlets are above the level of the cold-water storage tank.

Shower pumps, types STN and SSN, feature independent pressure and flow controls, with built-in non-return valves and stainless-steel expansion tanks in each pump end. This system ensures complete hot- and cold-water system isolation with stable control over a very wide flow range.

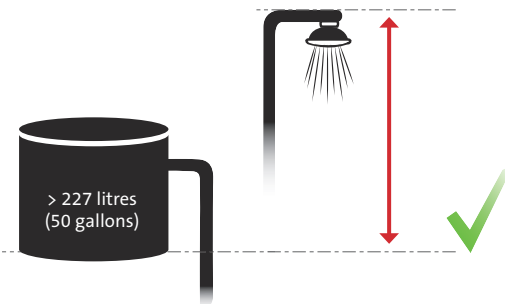

Fig. 32 Definition of universal-head pumps

6.2 Dry-running protection

STN, SSN, STC CN and STL 2.0 CN universal-head pumps feature dry-running protection to avoid damage to seals caused by water starvation. This condition is possible if the water supply fails, for instance if the water storage is insufficient or the pump strainers are blocked.

If the pump runs for 60 seconds with an insufficient water supply, the pump will stop and "lock out".

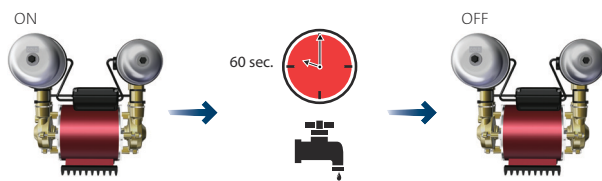

Fig. 33 Dry-running protection

Resetting the "lock out"

To reset the pump, switch off the power supply for ten seconds.

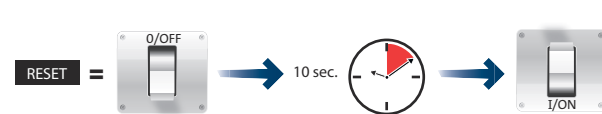

Fig. 34 Resetting dry-running protection

When the power supply is switched on again, the pump will run for a few seconds to recharge the tanks. If it continues to run and there is no demand, this would indicate that one of the following situations is still present:

- No water in the system.
- Blocked strainer.
- Air which has not yet cleared.

Caution *Continued dry running will lead to overheating of the shaft seals and eventually to a water leak.*

6.3 Connecting the pump

- Follow general instructions in section 3. *Installation*.
- Minimum head of water to supply the pump can be found on the nameplate.
- Maximum static head of 8 metres, i.e. the highest point of the system must be less than 8 metres above the pump. See fig. 35.



Fig. 35 Maximum static head

- Connect the pump side with the larger expansion tank to cold water and the pump side with the smaller expansion tank to hot water.

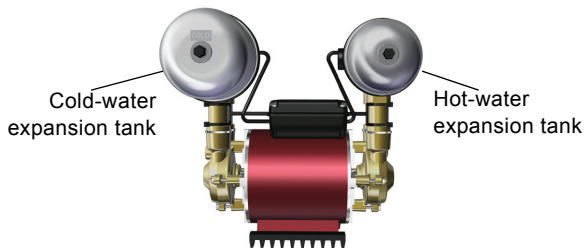

Fig. 36 Expansion tanks

6.4 Operating instructions

Taps and valves used on the "pressure system" must be fully turned off when not in use to avoid that the pump runs reciprocating on and off.

6.5 Installation options

Lavatory cisterns

If the pump is to supply a lavatory cistern, take the precautions below to avoid frequent starting and stopping of the pump due to low flow rates.

If possible, best practice is to supply the cistern from the mains water supply. If this is not possible, we recommend a "Torbeck" or equilibrium valve. If either of these are not possible, the following instructions should be followed:

- A: The pump is supplied with two expansion or pressure tanks. They have capacities of 500 ml and 300 ml. The larger tank must be used on the cold side of the pump.
- B: The cistern-filling pipework must be as free-flowing as possible with all flow restrictors removed. It is possible to change the tanks from one side of the pump to the other. When doing so, take care to ensure that none of the fibre washers are lost.

Washer dryers

- Only brass pumps must be used for these applications.

7. Technical data

Ambient temperature

Maximum 40 °C.

Storage temperature

Minimum -20 °C.
Maximum 70 °C.

Liquid temperature

See pump nameplate.

Minimum starting flow rate

0.5 l/min

Rated current

See pump nameplate

Insulation class

155 (F).

Enclosure class

IPx2.

Relative air humidity

Maximum 95 %.

Sound power level

The sound power level of the pump is lower than 70 dB(A).

Start/stop frequency

Maximum 100 per hour.

Maximum system pressure [bar]

STP, SSP: 6.
STC: 3.
STL, SSL: 3.
STR, SSR: 3.
STN, SSN: 6.

Inlet head [m]

See pump nameplate.

STP, SSP: 1-20.
STC: 2-10.
STC CN: 2-8.
STL, SSL: 2-10.
STL 2.0 CN: 2-8.
STR, SSR: 1-10.
STN, SSN: 1-8.

Maximum developed pump head [m]

See pump nameplate.

STP, SSP: 13-41.
STC: 15-20.
STL, SSL: 9.5 - 19.5.
STR, SSR: 12-16.
STN, SSN: 21-41.

Supply voltage

STP, SSP: 1 x 230 V, 50 Hz.
STC: 1 x 230 V, 50 Hz.
STL, SSL: 1 x 230 V, 50 Hz (for transformer) (transformer output 29-39 VDC, see nameplate).
STR, SSR: 1 x 230 V, 50 Hz.
STN, SSN: 1 x 230 V, 50 Hz.

Rating

STP, SSP*: Continuous operation.
STC*: 20 min. on, 40 min. off.
STL, SSL**: 30 min. on, 30 min. off.
STL 1.0 C): 20 min. on, 40 min. off.
STR, SSR*: 20 min. on, 40 min. off.
STN, SSN*: Continuous operation.

* Recommended minimum flow rate: 5 l/min.

** At flow rates between 5 and 20 l/min.

TM05 7310 0913

TM05 7314 0913

8. Fault finding

8.1 Positive-head pumps (STP, SSP, STC, STL, SSL, STR, SSR)



Warning

Before starting fault finding, switch off the power supply. Make sure that the power supply cannot be accidentally switched on.

Note

One of the most common causes of pump problems is air in the system.

Fault	Possible cause	Remedy
1. The pump fails to start.	a) The power supply is switched off.	Switch on the power supply.
	b) The fuses are blown.	Replace the blown fuses. If the new ones blow too, check the electrical installation.
	c) The built-in thermal protection has switched off the motor.	The thermal protection resets automatically within one to two hours.
	d) Pump installed with non-vertical discharge ports (flow switches).	The pump must be installed with vertical discharge ports (flow switches).
	e) Insufficient water flow, below 0.5 l/min.	Increase the water flow to at least 0.5 l/min.
2. The pump runs but delivers no water.	f) Isolating valves are closed.	Open the isolating valves.
	g) Strainers are blocked.	Close the isolating valves, clean the strainers and re-open the valves.
3. The flow from the shower drops.	a) Strainers are blocked.	Close the isolating valves, clean the strainers and re-open the valves.
4. The pump runs continuously.	a) A tap or outlet is open.	Ensure that there are no leaks and that all taps and appliances are closed.
	b) Air in the system.	Purge any air in the system. With the pump not running, allow maximum flow by removing the shower handset and allowing the hose to hang into the shower tray or bath. Operate maximum hot and cold flow for at least five minutes each. For fixed-head showers remove the shower rose and connect a length of hose, hanging into the shower tray or bath.
	c) The float in the flow switch is stuck in the up (on) position.	Make sure that the flow switch can operate correctly and there is no debris in the flow switch.
	d) Flow switch or reed switch faulty or incorrectly set.	Adjust or replace as appropriate.
5. The pump pulses.	a) The use of other taps in the house may cause the pump to start momentarily.	Ensure that taps or other outlets are not causing water hammer. A low-pressure non-return valve can be fitted on the outlet pipework from the pump. Contact your installer.
6. Unstable water temperature or noisy pump.	a) Air entering the pump, most commonly from the hot-water cylinder.	Fit a Surrey flange and study the pipework layout. There should be no high points where air can collect.
	b) Too high water temperature.	Reduce hot-water temperature. The maximum hot-water temperature setting is 60 °C.
	c) Debris caught in the impeller casing.	Remove debris.
7. Noisy pump.	a) Vibration through pump mounting surface.	Place the pump on a concrete slab to reduce noise.
8. Hose connection leaking.	a) Hose connection loose.	STC, STR, SSR, STL, SSL: Make sure that the hose washers and strainer washers are fitted. Check that the plastic nuts on the hoses are tight. STP, SSP: Make sure that the hose connection is fully inserted to a minimum depth of 33 mm.

Note

If correction of any of the above did not ensure successful operation, please call UK Service Helpline 01732 869700 before removing the pump from the installation.

8.2 Universal-head pumps (STN, SSN,STC CN and STL 2.0 CN)

**Warning**

Before starting fault finding, switch off the power supply. Make sure that the power supply cannot be accidentally switched on.

Note One of the most common causes of pump problems is air in the system.

Fault	Possible cause	Remedy
1. The pump fails to start.	a) The power supply is switched off.	Switch on the power supply.
	b) The fuses are blown.	Replace the blown fuses. If the new ones blow too, check the electrical installation.
	c) The built-in thermal protection has switched off the motor.	The thermal protection resets automatically within one to two hours.
	d) Pump installed with non-vertical discharge ports (flow switches).	The pump must be installed with vertical discharge ports (flow switches).
	e) Dry-running protection activated.	Switch off the power supply for ten seconds to reset. See section 6.2 <i>Dry-running protection</i> to eliminate the cause.
	f) Faulty or incorrectly set pressure switch.	Contact the helpline for adjustment or replacement details.
2. The pump runs but delivers no water.	a) Isolating valves are closed.	Open the isolating valves.
	b) Strainers are blocked.	Close the isolating valves, clean the strainers and re-open the valves.
3. The flow from the shower drops.	a) Strainers are blocked.	Close the isolating valves, clean the strainers and re-open the valves.
	b) Air in the system.	Purge any air in the system. With the pump not running, allow maximum flow by removing the shower handset and allowing the hose to hang into the shower tray or bath. Operate maximum hot and cold flow for at least five minutes each. For fixed-head showers, remove the shower rose and connect a length of hose hanging into the shower tray or bath.
4. The pump runs continuously.	a) A flow demand still exists.	Check the installation for leaks.
	b) Faulty pressure switch.	Contact the helpline for adjustment or replacement details.
	c) The float in the flow switch is stuck in the up (on) position.	Make sure that the flow switch can operate correctly and there is no debris in the flow switch.
	d) Flow switch or reed switch faulty or incorrectly set.	Adjust or replace as appropriate.
5. The pump pulses.	a) The use of other taps in the house may cause the pump to start momentarily.	Contact your installer.
	b) Leaks in the system.	Check the system for leaks.
	c) Faulty non-return valve.	Check the non-return valves and replace, if necessary.
6. The pump does not run even though there is a demand.	a) Flow demand below 0.5 l/min.	Open a tap to increase the flow demand.
	b) Flow switch or reed switch faulty.	Replace the flow switch or reed switch.
	c) Dry-running protection activated.	Switch off the power supply for ten seconds to reset. See section 6.2 <i>Dry-running protection</i> .
7. Pump hunts when shutting down.	a) Incorrect tank air-pressure setting.	Adjust the tank air-pressure setting.
	b) Insufficient run-on time.	Replace the printed-circuit board (PCB).
8. Pump hunts when starting up.	a) Flow rate below 0.5 l/min.	Increase the flow rate.
	b) Flow switch or reed switch faulty or incorrectly set.	Adjust or replace as appropriate.
9. Noisy pump.	a) Vibration through pump mounting surface.	Place the pump on a concrete slab to reduce noise.
10. Hose connection leaking.	a) Hose connection loose.	STC CN and STL 2.0 CN: Make sure that the hose washers and strainer washers are fitted. Check that the plastic nuts on the hoses are tight. STN, SSN: Make sure that the hose connection is fully inserted to a minimum depth of 33 mm.

Note If correction of any of the above did not ensure successful operation, please call UK Service Helpline 01732 869700 before removing the pump from the installation.

9. How it works

This section gives a short description of how the different pump functions work.

Pump functionality

- To achieve 0.5 l/min. to turn the flow switches on, there must be a minimum height between the bottom of the cold-water storage tank and the highest point of the outlet pipework or the shower outlet of at least 250 mm.
- The pump control will automatically turn the pump on and off when water is consumed. The power supply to the pump can therefore be left on at any time.

Use of flanges

- We do not recommend that you take the hot-water supply directly from the top of the hot-water cylinder, as entrapped air may cause problems such as airlocks in the supply pipe.
- Excessive air entering the pump will cause faulty operation and damage to the pump seals which will cause water leaks.

Valves

- Do not fit any non-return valves in the inlet pipework as the pump must be able to vent back to the cold-water storage tank and hot-water cylinder.

Startup and operation (STL, SSL)

- If the transformer overheats for any reason, the thermal cut-out will switch the pump off. The cut-out will automatically switch the pump on again when the transformer has cooled down.
- Connect the low-voltage leads from the transformer to the two terminals marked "T" in the pump terminal box. As the supply is AC, the leads can be connected to either terminal.

9.1 Universal-head pumps

- All air must be thoroughly purged from the system. If air is present in the pump, it will be unable to generate sufficient pressure to operate the pressure switch. This will cause the pump to run or pulse continuously.
- Any leak or drip will cause the pump to operate periodically, the frequency dependent on the rate of the leak.

Pressure and flow control

Shower pumps for universal-head applications are controlled by both water pressure and water flow.

Twin-impeller pumps incorporate two separate pressure and flow control systems, one on each pump end, ensuring complete isolation of hot- and cold-water systems and consistent operation over a wide range of unbalanced flow rates.

The control system manifold includes an integral non-return valve to maintain system pressure when water is not flowing.

Operation

The pressure switches start the pump on falling pressure. The switch point is factory-set.

Note

It is important that the total head on the pump is less than 8 metres. Otherwise, the pressure switch can never operate and hence the pump will fail to start.

Once the pump has been started by the pressure switches, the flow switches maintain the pump running, providing the flow rate is above 0.5 l/min. When the flow rate drops below 0.5 l/min., or the demand is turned off, the pump will stop after first running on for three seconds to recharge the pressure tanks.

10. Engineer check list

- Minimum 227 litres (50 gallons) of water of stored cold water.
- 22 mm pipework if the pump is rated 2.0 bar or greater.
- Dedicated, independent supply from hot-water cylinder and cold feed from tank.
- At least 2 m head from water level in cold-water storage tank to top of pump (1 m on SSR, STR, SSP, STP, SSN and STN pumps).
- Anti gravity loop if the pump is sited above hot-water cylinder.
- The pump must not be connected directly to mains pressure water (Combi, Unvented, Thermal Store, etc.).
- Highest point of pipework must be at least 250 mm below the base of the cold-water storage tank (not applicable for universal-head pumps).
- Hot-water temperature must not exceed 60 °C (cylinder must have thermostat).

If correction of any of the above did not ensure successful operation, please call 01732 869700 and select option 2 to speak to a technical advisor.

11. Maintenance and service

- Inspect all flexible hoses and connections at least every six months, as water temperature and mechanical stress, can cause the hoses to deteriorate with age. Replace as necessary to prevent leaks. Only hoses designed for the pump can be used.
- Clean strainers every six month, or when needed. If the flow from the shower drops below its normal performance, it may be necessary to clean the pump strainers. Blocked strainers are common on initial installation of pumps, or in new buildings where the use of jointing compounds, tapes, flux and other debris can be flushed through the system. In this event, close the isolating valves, remove and clean the strainers. See section 5. *Startup*.
- Washers and seals must be replaced when necessary to prevent leaks or drips.
- If the supply cord is damaged, it must be replaced by the manufacturer, the service agent or similarly qualified persons in order to avoid a hazard.
- A common cause of poor shower performance is a clogged shower head/handset, so regular cleaning and descaling is important. This applies particularly to hard-water areas.
- If you have any questions, please contact UK Service Helpline 01732 869700.

Tank air-pressure setting (universal-head pumps)

The pressures are factory-set. In the event of a leak, they should be set as follows:

The smaller tank (300 ml) should be set at a pressure between 0.9 and 1.0 bar. The larger tank (500 ml) should be set at a pressure between 0.5 and 0.6 bar.

Note

In certain applications, e.g. steam cabinets, it may be necessary to increase the pressure. Consult the appliance manufacturer.

12. Disposal

This product or parts of it must be disposed of in an environmentally sound way:

1. Use the public or private waste collection service.
2. If this is not possible, contact the nearest Grundfos company or service workshop.

Subject to alterations.

1. General installation concerns

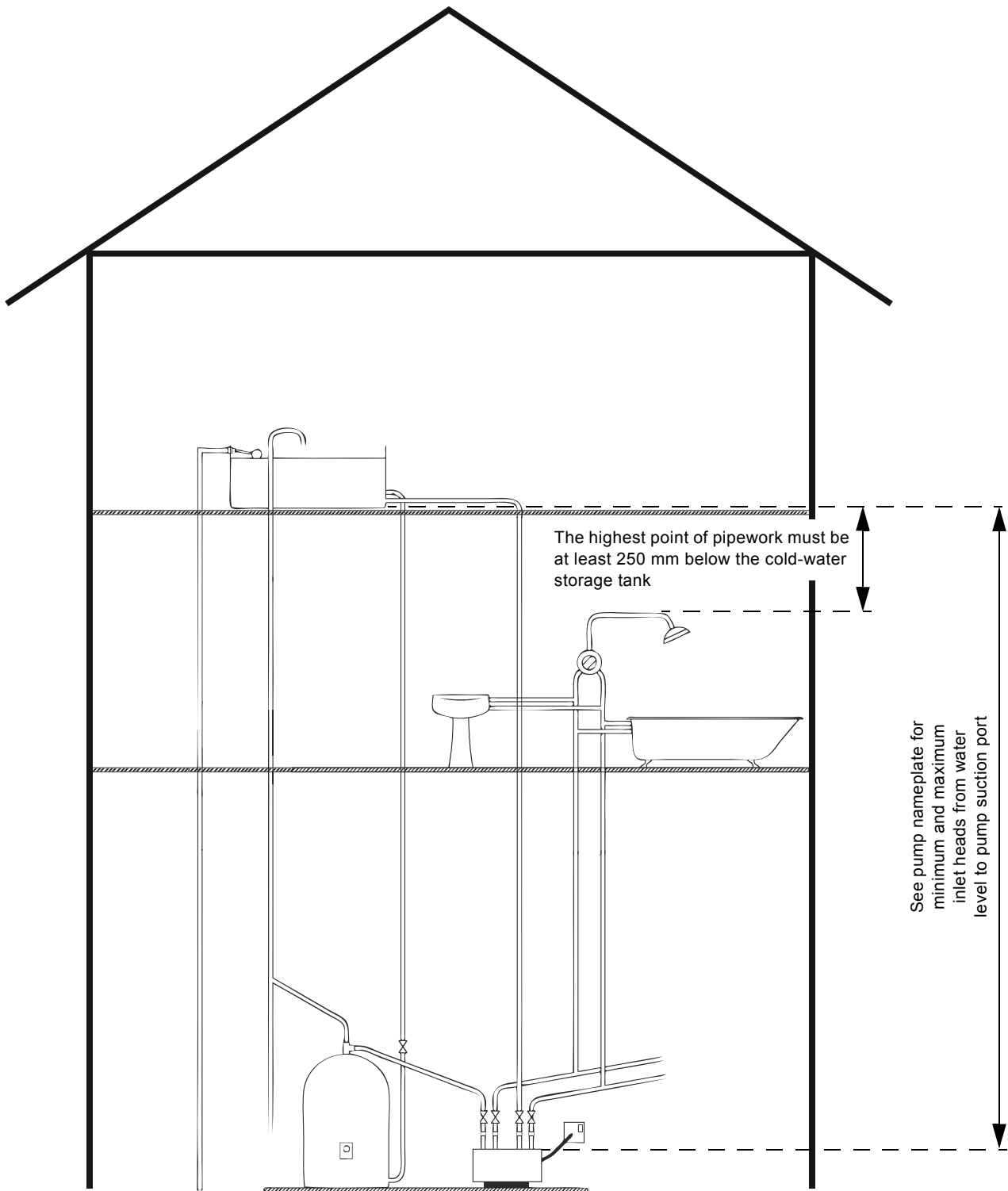

Fig. 1 Example of installation for positive-head pumps and installation heights required

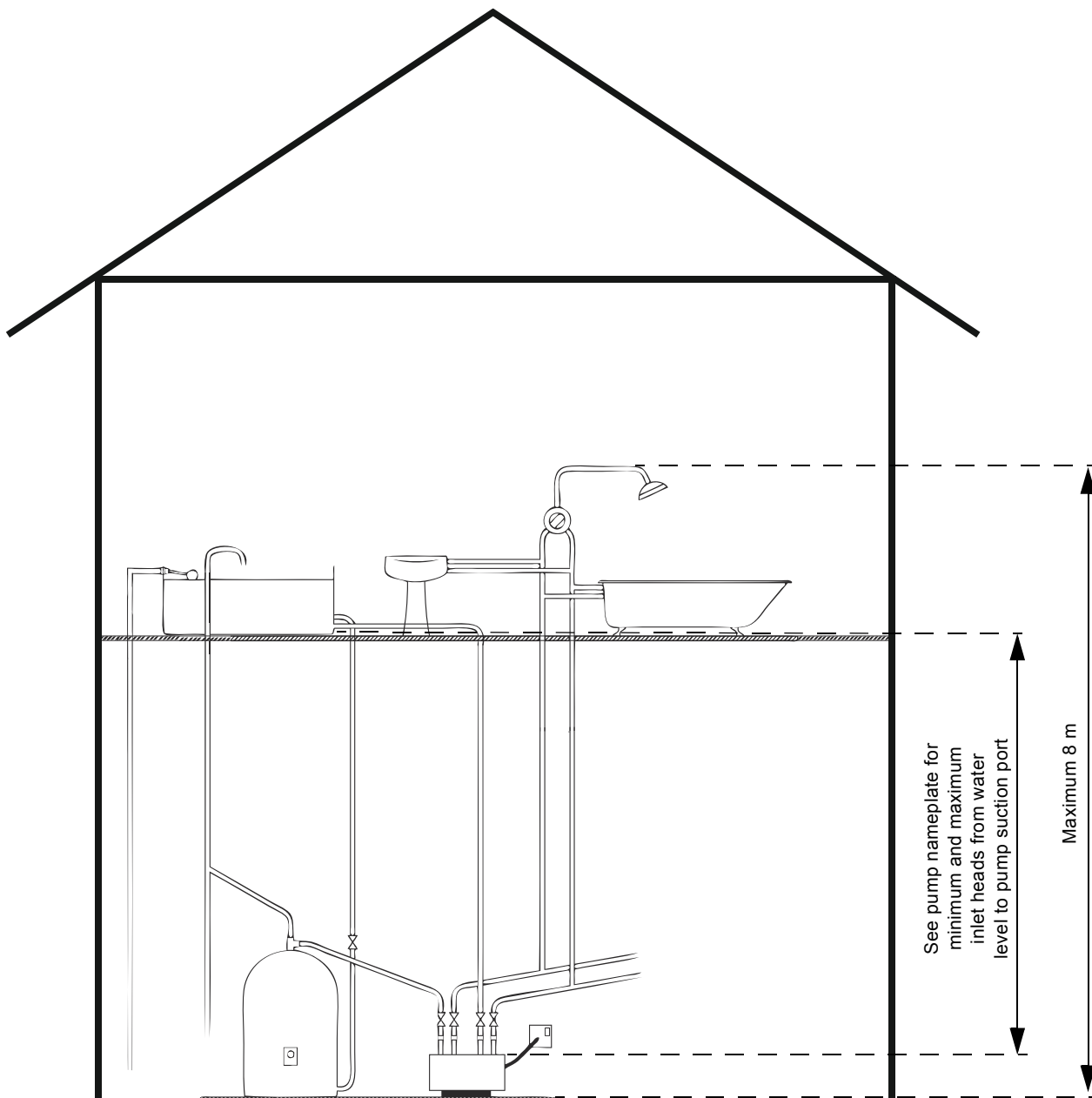

Fig. 2 Example of installation of universal-head pumps and installation heights required

TM05 8351 2413

Declaration of conformity

GB: EC declaration of conformity

We, Grundfos, declare under our sole responsibility that the products SSL, STL, STC, SSR, STR, SSP, STP, SSN and STN, to which this declaration relates, are in conformity with these Council directives on the approximation of the laws of the EC member states:

- Low Voltage Directive (2006/95/EC).
Standards used: EN 60335-1:2012 and EN 60335-2-41:2003.
- EMC Directive (2004/108/EC).

Bjerringbro, 17 November 2014



Svend Aage Kaae
Technical Director
Grundfos Holding A/S
Poul Due Jensens Vej 7
8850 Bjerringbro, Denmark

Person authorised to compile the technical file and
empowered to sign the EC declaration of conformity.

96787913 1214

ECM: 1148101
