

USER MANUAL



Thank you for choosing Better Bathrooms.
Please read this manual before installing your product
and keep for future reference.

better 
bathrooms

BeBa_25349 to BeBa_25363 and BeBa_27949 Margo Towel Radiator

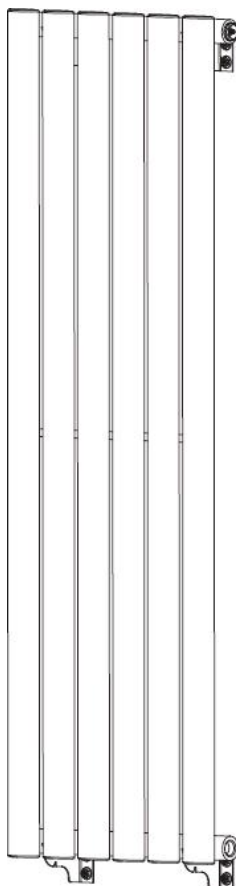

Please note: Image is for illustrative purposes only and may differ slightly to the actual product

- **Multi-person assembly**
- **Tools required**
- **We always recommend using professional tradespeople to install your product**

V2_21.07.21

Congratulations on your purchase

And welcome to our growing gang of savvy shoppers

We're on a mission to bring you extraordinary bathroom products, for less. From modern to traditional style ceramics, plus the gorgeous fixtures, fittings and furniture to match. So, you can fall in love with your space every single day.

As one of the UK's largest independent bathroom stores, we've received countless awards; including the National Business Awards UK, the Digital Entrepreneur Awards and being placed on The Sunday Times Fast Track 100.

We hope your new product exceeds your highest expectations. However, if you experience any problems, please:

- call our friendly UK call centre on **0330 390 3062** (9am-7pm Monday to Friday, or 10am-4pm Saturday and Sunday), or
- send us a message via **customerservices@buyitdirect.co.uk**

Important information

- Please read these instructions thoroughly and retain for future reference
- Manufactured to BS EN 442-1 Radiators and convectors
- Please ensure that the product is checked for damage prior to installation, any damage reported after installation will not be covered.
- The pipework must be flushed out to remove any debris which can affect the function of this product.
- A corrosion inhibitor should be used in your installation.

BTU & Wattage info-

Product Code	BTU	Wattage
BeBa_25349	1442	335
BeBa_25350	1714	502
BeBa_25351	2286	670
BeBa_25352	1634	479
BeBa_25353	2392	701
BeBa_25354	2873	842
BeBa_25355	3323	974
BeBa_25356	2873	842
BeBa_25357	3886	1139
BeBa_25358	1634	479
BeBa_25359	2392	701
BeBa_25360	2347	688
BeBa_25361	3323	974
BeBa_25362	2873	842
BeBa_25363	3886	1139
BeBa_27949	6299	1849

Parts

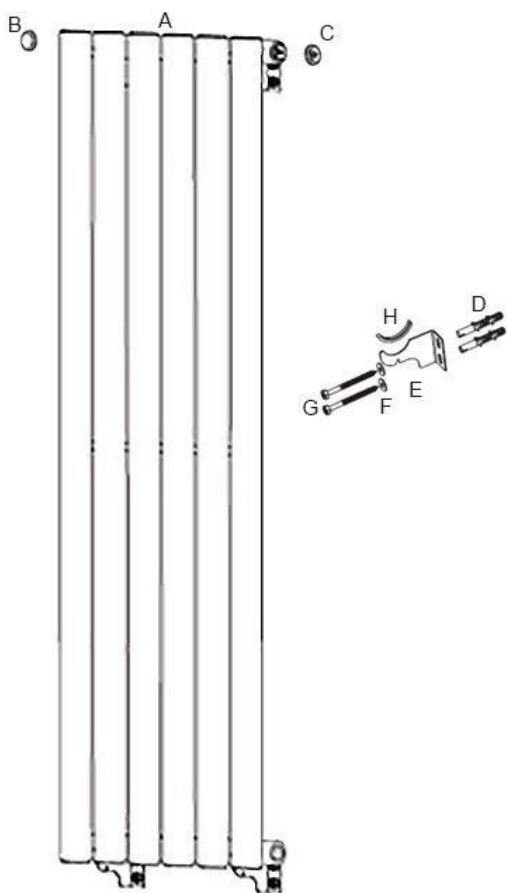

- A. 1 x Radiator
- B. 1 x Air Vent (Bleed Valve)
- C. 1 x Blanking Cap
- D. 8 x Wall Plug
- E. 4 x Wall Bracket
- F. 8 x Washer
- G. 8 x Wall screw
- H. 4 x Wall Bracket Cover

Please note that Parts are for illustrative purposes only and may differ slightly to the actual product

Tools required

Spanner

Flathead screwdriver

Philips screwdriver

Tape measure

Drill and 8mm drill bit

Spirit Level

Pencil

Sealing tape

Installation

Please note: Before starting any installation, turn off the water supply.

Please note: Before commencing any installation, the desired location should be checked before drilling, that no pipes or wires can be damaged.

First, prepare the water supply pipes to match up with the towel radiator and valve dimensions being used. Fit the radiator valve tail and nut into the towel rail (at both sides) and using sealing tape, tighten into position, then follow the installation below.

1. Insert the blanking cap and air vent in the top of the railway at either side, (add a little sealer tape to secure) and tighten using the spanner, be sure not to overtighten.

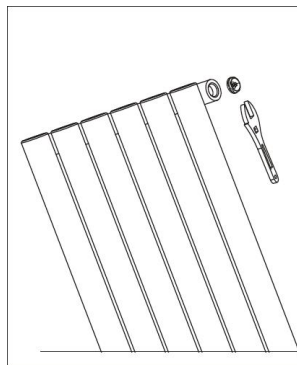

2. Set the position of the wall hanging brackets (on the wall) in relation to the size of your rail, the brackets should be located between the last bar and the second bar in, as shown. Mark these positions on the wall in the required location and use a spirit level to ensure that these are horizontally and vertically aligned.

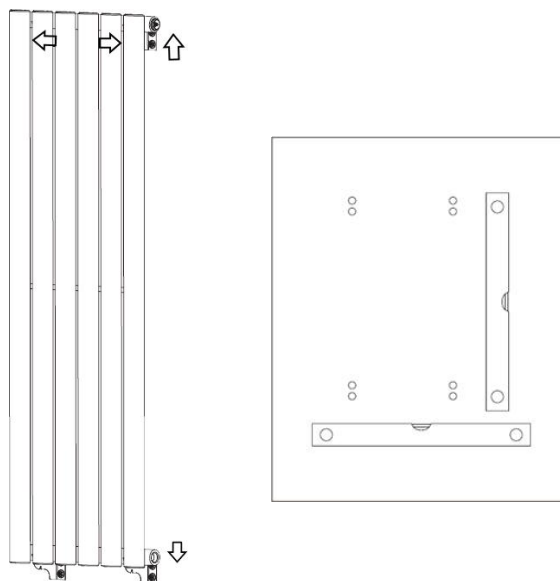

- Using the drill and 8mm drill bit, drill into the marked positions then insert the wall plugs and tap flush to the finished wall surface.

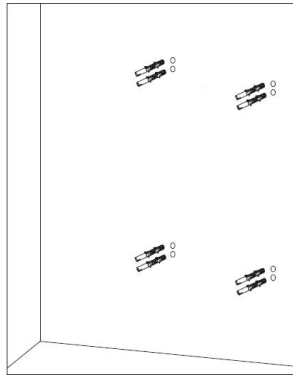

Please note: If drilling into tile, it is recommended to tape the wall to prevent the drill from slipping.

- Next, position the wall brackets and screw into place using the screws provided (securing each with a washer) with the Philips screwdriver. Then place the bracket covers over the curved section of the bracket which sits between the rail and the bracket.

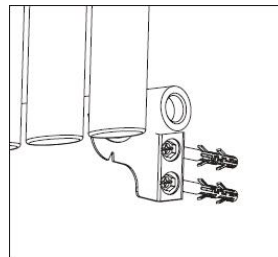
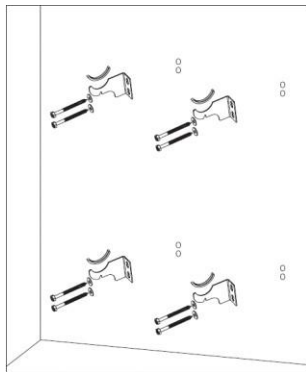

- Once all brackets are secure, hang the radiator until fixed firmly into place and adjust so that the rail aligns with the pipework.

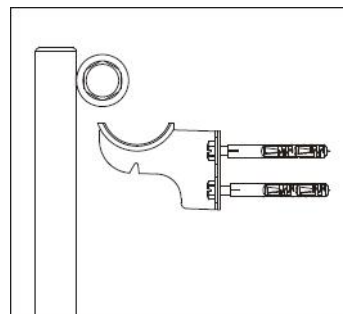
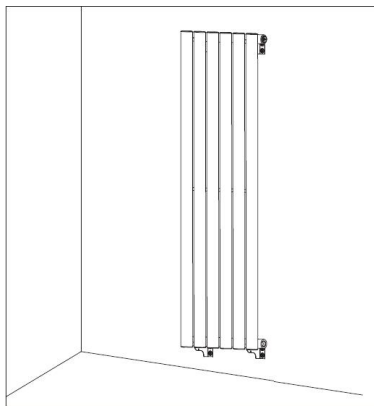

Please note: You may need two people to hang the radiator, depending on the model purchased.

6. Finally, fit the radiator valves to the pipework and connect to the radiator valve tail and tighten all connections.

IMPORTANT! The product is supplied un-filled.

The rail should be filled with a water (80%) and glycol (20%) mixture if **NOT** being connected to the central heating system, also allow 5% air gap.

After installation

- After the above installation, turn on the water supply and using the flathead screwdriver, open the air vent via the central screw, open the inlet valve and let the water rush into the radiator. Check all connections for leaks.
- Once water overflows from the air vent, this means that there will be no air bubbles present.
- Use a screwdriver to close the air vent and then the radiator is ready to use.

Cleaning

This radiator is made from steel with a painted finish. To maintain the surface of your product, wipe with a clean damp cloth and wipe dry.

Do not use abrasive cleaning agents or materials which can strip and scratch the surface; the use of these agents or materials can invalidate your guarantee.

It is recommended to wipe and dry on a regular basis.

For more information

- visit betterbathrooms.com
- email customerservices@buyitdirect.co.uk
- call 0330 390 3062
- write to Trident Business Park, Neptune Way, Huddersfield, HD2 1UA

better 
bathrooms

Part of the BuyItDirect Group