

LEG & PANEL PACK FITTING INSTRUCTIONS

Raised tray installation instructions. Please read these instructions prior to installation.

760 PANEL PACK CONTENTS - 195

1 x 760 Panel

1 x 760 Panel

2 x Wood Blocks

4 x Panel Clips

2 x Wall Fixing Brackets

12 x Bolts

8 x Screws

2 x Adjustable Feet (inner)

4 x Adjustable Feet (outer)

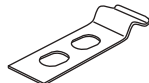
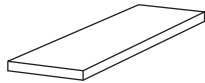

8 x Star Washers

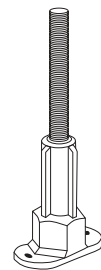
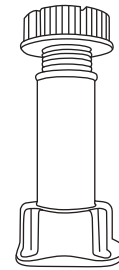

1200 PANEL PACK CONTENTS - 196

1 x 1200 Panel

1 x 1000 Panel

2 x Wood Blocks

5 x Panel Clips

2 x Wall Fixing Brackets

18 x Bolts

8 x Screws

2 x Adjustable Feet (inner)

6 x Adjustable Feet (outer)

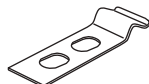
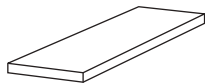

12 x Star Washers

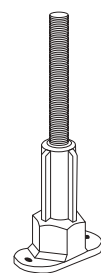
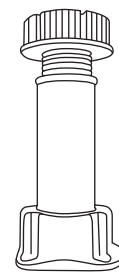

1700 PANEL PACK CONTENTS - 197

1 x 1700 Panel

1 x 1000 Panel

4 x Wood Blocks

5 x Panel Clips

2 x Wall Fixing Brackets

18 x Bolts

16 x Screws

4 x Adjustable Feet (inner)

6 x Adjustable Feet (outer)

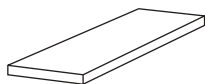

12 x Star Washers

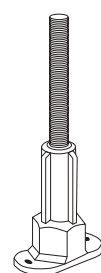
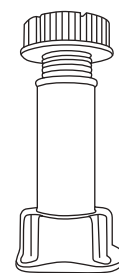

900 QUAD PANEL PACK CONTENTS - 198

1 x 900 Panel

2 x Wood Blocks

2 x Adjustable Feet (inner)

4 x Adjustable Feet (outer)

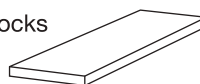
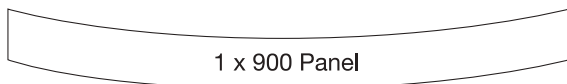

4 x Panel Clips

2 x Wall Fixing Brackets

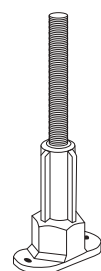
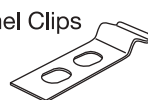

1000 QUAD PANEL PACK CONTENTS - 194

1 x 1000 Panel

12 x Bolts

8 x Star Washers

8 x Screws



1200 QUAD PANEL PACK CONTENTS - 199

1 x 1200 Panel

8 x Screws

2 x Adjustable Feet (inner)

6 x Adjustable Feet (outer)



2 x Wood Blocks

5 x Panel Clips

2 x Wall Fixing Brackets

18 x Bolts

12 x Star Washers

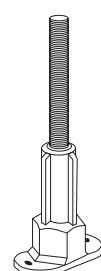
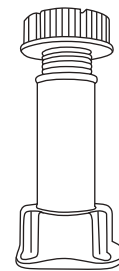
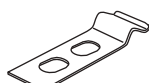

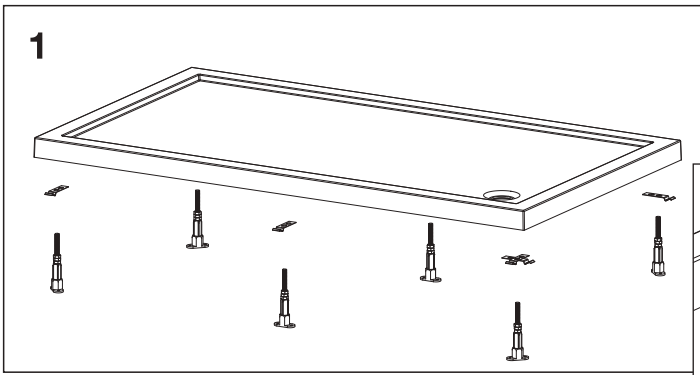

1. Fix the legs and panel clips to the base of the tray by screwing the leg through the clip and into the inserts (which are installed into the base of the tray as standard) to give an evenly supported structure.

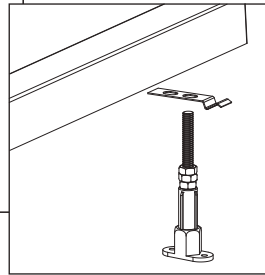

Please Note: Legs are adjustable by 15mm for out of level floors

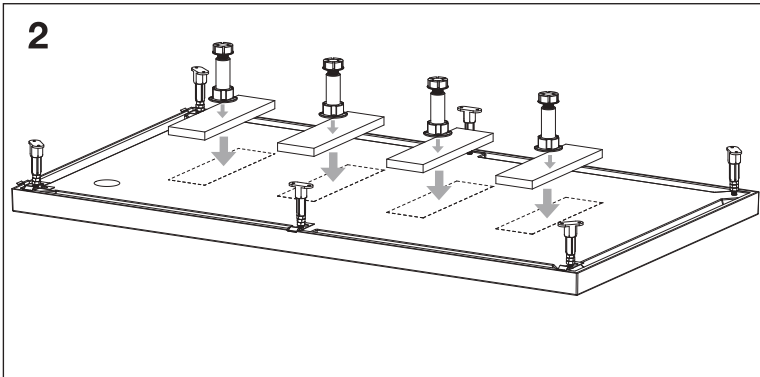

2. Evenly distribute the wood blocks along the centre of the base and silicone in place. Leave to set following the manufacturer's guidelines.

The adjustable centre feet will need cutting down to required height

- (a) using a hacksaw cut to required size, DO NOT cut the threaded end
- (b) push back together
- (c) screw the adjustable feet onto the wood blocks
- (d) Adjust the height of the legs to ensure that the cover panel will fit and that the shower tray is level.

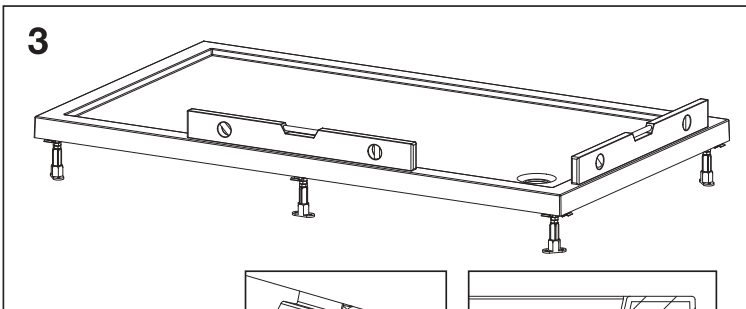
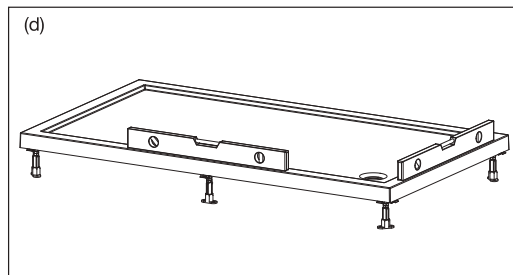
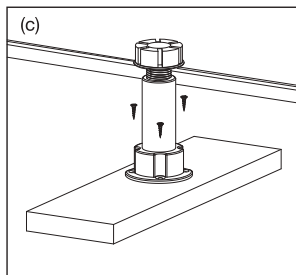
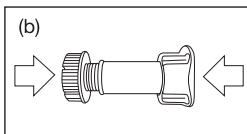
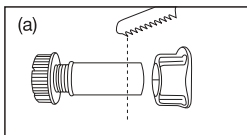

3. Level the tray around the rim, place a bowl under the tray, pour in water. Due to water retention, large droplets of water will remain but large pools should not be evident. Fit the waste to the tray (as per manufacturers recommendation). We recommend the use of a fast flow waste with this tray. Ensure the tray is positioned against both walls. Again, ensure the tray is level using a spirit level. Connect the waste pipe to the waste and water test the connections for leaks and tray water retention.

Once you are happy with the installation process, fasten the legs to the floor with suitable screws then secure the tray to the walls using the wall brackets provided (floor and wall screws not supplied).

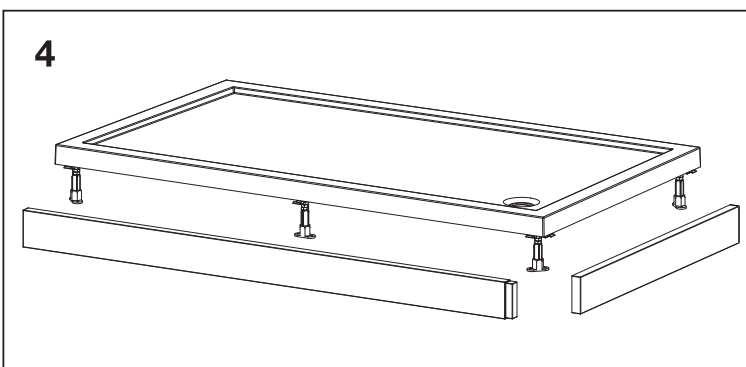

4. Cut the panels to required size and push the cover panel into place using the panel clips under the lip of the tray to secure.

Once in position apply a secondary silicone seal between the tray and the wall.

Diagrams show 1700 panel pack and are for illustrative purposes only