

Cement Coated Insulation boards

Installation (Floors)

Concrete Floors

STEP 1 - The subfloor must be clean and dry and if necessary, smoothed with a latex/cement self-levelling compound to give an SR1 surface regularity.

STEP 2 - The insulation board should be installed using a flexible, cement-based adhesive. The adhesive should be trowelled out and combed through with a 6/8 mm notched trowel to give a ribbed bed, any slight depressions being filled by the mortar.

STEP 3 - The boards should be laid on the freshly applied ribbed bed and thoroughly bedded in to ensure that no voids are left beneath the boards and they are solidly supported. All boards should be laid with staggered joints.

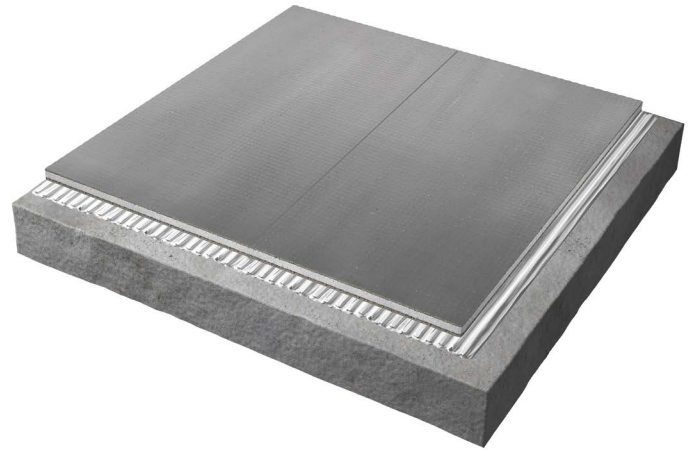

Timber Floors

STEP 1 - The subfloor must be clean and dry. Existing floorboards should be structurally sound and if necessary, smoothed with a latex/cement self-levelling compound to give an SR1 surface regularity.

STEP 2 - The insulation board should be installed using a flexible, cement-based adhesive. The adhesive should be trowelled out and combed through with a 6/8 mm notched trowel to give a ribbed bed, any slight depressions being filled by the mortar.

STEP 3 - The boards should be laid on the freshly applied ribbed bed and thoroughly bedded in to ensure that no voids are left beneath the boards and they are solidly supported. All boards should be laid with staggered joints.

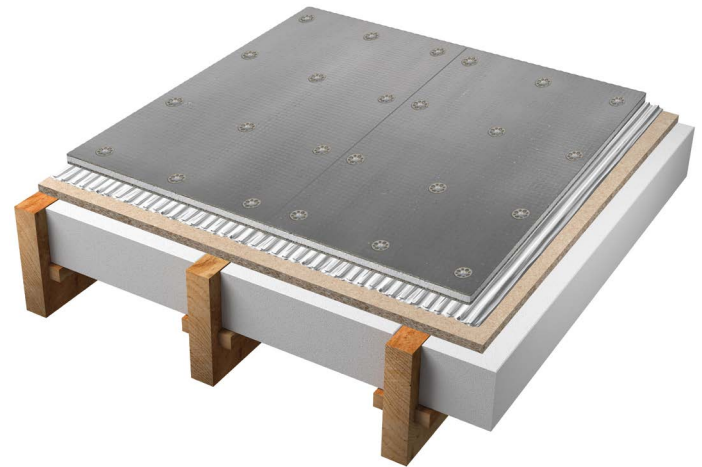

STEP 4 - When the adhesive has cured, the boards should be secured using screws and washers. These are installed at the rate of 12 per board (3 rows of 4). The screws should be a minimum of 30 mm from the edge of the insulation board. Tighten the screw and washer into the board until the screw head is flush with the surface.

NOTE: Allow the adhesive attaching the boards to the subfloor to cure before laying electric underfloor heating directly onto the boards. Tile over heater using cement-based flexible adhesive and grout.

WATERPROOFING: To attain waterproof joints the boards should be sealed during installation using silicone sealant. The sealant should be applied to the edge of the fixed board immediately prior to the next board being installed and placed in position.

Installation (Walls)

Solid walls

STEP 1 - The substrate must be clean and dry. It is possible to adhere the boards to existing plaster however plastered walls must be sealed before fixing the boards.

STEP 2 - The insulation board should be installed using a flexible, cement-based adhesive. The adhesive should be trowelled out and combed through with a 6/8 mm notched trowel to give a ribbed bed, any slight depressions being filled by the mortar.

STEP 3 - The boards should be laid on the freshly applied ribbed bed and thoroughly bedded in to ensure that no voids are left beneath the boards and they are solidly supported. All boards should be laid with staggered joints.

NOTE: Allow the adhesive attaching the boards to the substrate to cure before laying electric wall heating directly onto the boards. Tile over heater using cement-based flexible adhesive and grout.



Stud walls

IMPORTANT: For stud walls at 600 mm centres you must use 20 mm insulation boards or thicker. 10 mm boards are suitable for stud walls at 300 mm centres only.

STEP 1 - All board edges must be supported by noggins. Install noggins between studwork where board edges are likely to need supporting.

STEP 2 - The insulation board should be installed using screws and washers. These should be applied every 300 mm on each stud. For studs at 600 mm, use 2 rows of 5 fixings. At 300 mm centres use 3 rows of 5 fixings. All boards should be laid with staggered joints.

STEP 3 - Tighten the screw and washer into the board until the screw head is flush with the surface.

NOTE: Electric wall heating can be applied directly onto the boards. Tile over heater using cement-based flexible adhesive and grout.

WATERPROOFING: To attain waterproof joints the boards should be sealed during installation using silicone sealant. The sealant should be applied to the edge of the fixed board immediately prior to the next board being installed and placed in position.



Electric
Heating System

Warmup plc,
702 Tudor Estate T: 0345 345 2288
Abbey Road F: 0345 345 2299
London uk@warmup.com
NW10 7UW www.warmup.co.uk

Warmup - IM - INSBOARDS - v1.4 2018-05-11

Warmup

The world's best-selling floor heating brand™

Warmup

The world's best-selling floor heating brand™

Warmup StickyMat SPM

Installation Manual

TECHNICAL HELPLINE

0845 345 2288

CE

SAFETY Net™
INSTALLATION
GUARANTEE

IMPORTANT!

Read this manual before attempting to install your Warmup heater. Incorrect installation could damage the heater and will invalidate your warranty. Complete and submit your warranty from **online at www.warmup.co.uk**



Technical Information

SPM 150W/m²

	m	<--->	m	W	(-5%)	Ω	(+5%)	A
SPM 1m ²	0.5	x	2	150	335.1	352.7	370.3	0.65
SPM 1.5m ²	0.5	x	3	225	223.3	235.1	246.9	0.98
SPM 2m ²	0.5	x	4	300	167.5	176.3	185.1	1.30
SPM 2.5m ²	0.5	x	5	375	134.01	141.06	148.11	1.63
SPM 3m ²	0.5	x	6	450	111.72	117.6	123.5	1.96
SPM 3.5m ²	0.5	x	7	525	95.72	100.76	105.80	2.28
SPM 4m ²	0.5	x	8	600	83.76	88.17	92.6	2.61
SPM 4.5m ²	0.5	x	9	675	74.45	78.37	82.29	2.93
SPM 5m ²	0.5	x	10	750	67	70.53	74.1	3.26
SPM 6m ²	0.5	x	12	900	55.84	58.78	61.7	3.91
SPM 7m ²	0.5	x	14	1050	47.86	50.38	52.9	4.57
SPM 8m ²	0.5	x	16	1200	41.9	44.08	46.3	5.22
SPM 9m ²	0.5	x	18	1350	37.23	39.19	41.1	5.87
SPM 10m ²	0.5	x	20	1500	33.51	35.27	37.0	6.52
SPM 11m ²	0.5	x	22	1650	30.45	32.06	33.7	7.17
SPM 12m ²	0.5	x	24	1800	27.92	29.39	30.86	7.83
SPM 15m ²	0.5	x	30	2250	22.33	23.51	24.7	9.78

Voltage
230VAC ~ 50Hz
Minimum bending radius
25mm
IP rating
IPX7
Minimum Wire Spacing
50mm
Minimum Installation Temperature
5°C

SPM 200W/m²

	m	<--->	m	W	(-5%)	Ω	(+5%)	A
2SPM 0.5m ²	0.5	x	1	100	502.55	529.0	555.45	0.44
2SPM 1m ²	0.5	x	2	200	251.28	264.5	277.73	0.87
2SPM 1.5m ²	0.5	x	3	300	167.52	176.3	185.15	1.30
2SPM 2 m ²	0.5	x	4	400	125.64	132.3	138.86	1.74
2SPM 2.5m ²	0.5	x	5	500	100.51	105.80	111.09	2.17
2SPM 3m ²	0.5	x	6	600	83.76	88.2	92.58	2.61
2SPM 3.5m ²	0.5	x	7	700	71.79	75.57	79.35	3.04
2SPM 4m ²	0.5	x	8	800	62.82	66.1	69.43	3.48
2SPM 4.5m ²	0.5	x	9	900	55.84	58.78	61.72	3.91
2SPM 5m ²	0.5	x	10	1000	50.26	52.9	55.55	4.35
2SPM 6m ²	0.5	x	12	1200	41.88	44.1	46.29	5.22
2SPM 7m ²	0.5	x	14	1400	35.90	37.8	39.68	6.09
2SPM 8m ²	0.5	x	16	1600	31.41	33.1	34.72	6.96
2SPM 9m ²	0.5	x	18	1800	27.92	29.4	30.86	7.83
2SPM 10m ²	0.5	x	20	2000	25.13	26.5	27.77	8.70
2SPM 15m ²	0.5	x	30	3000	16.74	17.63	18.51	13.04

Contents

Technical Specifications	2
Introduction	3
Do's and Don'ts	
Floor Coverings	
What you Need for Installation	5
Subfloor Preparation	
Testing the Heater	
Electrical Safety Considerations	6
How to Modify the Mat	
Installing the Mat	7
Installing the Mat Continued	8
Warranty	9
Control Card	10
Documentation of Ownership, Installation and Part P Electrical Connection	11

WARNING

Your Warmup[®] Underfloor heating mat has been designed so that installation is quick and straight forward, but as with all electrical systems, certain procedures must be strictly followed. Please ensure that you have the correct heater(s) for the area you wish to heat. Warmup plc, the manufacturer of the Warmup[®] Sticky Mat, accepts no liability, expressed or implied, for any loss or consequential damage suffered as a result of installations which in any way contravene the instructions that follow. It is important that before, during and after installation that all requirements are met and understood. If the instructions are followed, you should have no problems. If you do require help at any stage, please contact our helpline:

0845 345 2288

You may also find a copy of this manual, wiring instructions and other helpful information on our website:

www.warmup.co.uk

Do's and Don'ts

DO

Carefully read this instruction manual before commencing installation. Consult our helpline or a competent professional if you are unsure how to proceed.

Ensure the system is tested before, during and after installation.

Plan your mat layout and installation so that any drilling after tiling (e.g. for sanitary ware) will not damage the wiring.

Maintain a minimum gap of 50mm between wire runs and from conductive parts such as water pipes.

Check that the mat is working immediately before commencing tiling.

Take particular care when tiling not to dislodge or damage the heating wire. Ensure that during the course of the installation that no damage is caused by, for example, falling objects, sharp objects etc.

Wear gloves to prevent irritation from the fibreglass mesh.

Ensure the end cap and manufactured joint are under a full bed adhesive or levelling compound and covered with a tile.

Ensure that a heat loss calculation has been carried out and heating requirements have been met if you are using the underfloor heating system as a primary source of heating.

Ensure that the heaters are separated from other heat sources such as luminaires and chimneys.

Ensure that the maximum thermal resistance of the floor does not exceed $0.15 \text{ [m}^2\text{K / W]}$.

Ensure that the control card at the back of the manual is completed and fixed at the main consumer unit along with any plans and electrical test records. As per the current BS7671:2008 17th Edition wiring regulations.

DON'T

Cut or shorten the heating element at any time.

Commence installation on a concrete floor that has not been fully cured.

Leave surplus matting rolled up under units or fixtures - **USE THE CORRECT SIZE MAT.**

Install the mat on irregular surfaces such as stairs or up walls.

Use staples to secure the the heating element to the subfloor.

Run the floor sensor wire or power lead over or under the heating element or close to other heat sources such as hot water pipes.

Connect two mats in series, only connect mats in parallel.

Commence tiling before testing the mat.

Switch on the installed mat until 8 days after fitting to allow the tile adhesive to dry completely.

Install the mat in temperatures less than $+5^{\circ}\text{C}$.

Bend the heating cable under 25mm radius.

Use the heating system to dry out levelling compound or adhesive.

Tape over the end cap or manufactured joint.

Attempt a DIY repair if you damage the heater. Contact Warmup on 0845 345 2288. If you accidentally damage a the heating mat BEFORE tiling, under the Warmup Safetynet guarantee you may return the damaged heater to Warmup, who will replace the heater FREE OF CHARGE. See details of the safety net warranty at the back of the manual.

Floor Coverings

This installation manual gives instruction for installation of the Warmup underfloor heating mat under ceramic, quarry or natural stone tiles. The maximum thermal resistance of the floor must not exceed $0.15 \text{ [m}^2\text{K / W]}$.

It is possible to install the heating element under floor finishes such as wood or vinyl by applying a self levelling compound over the heating mat. You must ensure that all heating cables are completely covered with a minimum of 10mm self levelling compound. It is important that the levelling compound is suitable for use with underfloor heating.

NOTE: Delicate floor finishes such as wood or vinyl have a maximum floor surface temperature of 27°C . This temperature must **NOT** be exceeded. Please contact Warmup for further advice if you wish to install the underfloor heating mat under any floor finishes other than ceramic, quarry or natural stone tiles.

What You Need for Installation

Components included in your Warmup SPM kit:

- Warmup SPM Mat
- Installation Manual

Additional components needed as part of your Warmup heating installation:

- A Warmup® Thermostat with floor sensor
- 30mA Residual Current Device (RCD), required as part of all installations
- Digital Multi-meter required for testing the resistance of the mat and floor sensor
- Electrical housing, back boxes and junction boxes.
(Back box for the thermostat must be at least 35mm deep)
- Electrical trunking/conduit for housing the power leads
- Duct Tape (to secure the floor sensor and loose wires)
- Scissors for cutting the fibreglass mesh
- Gloves
- Warmup® Insulation Boards.

NOTE: Only Warmup® Thermostats should be used.

Subfloor Preparation

Wooden Subfloors

- Ensure adequate underfloor ventilation
- Existing floorboards need to be securely fixed and if necessary pre-levelled with a latex/cement self-levelling compound to give a flush fit for the subsequently applied WBP plywood (18mm) or an insulated tile backer board (10mm) (Warmup® Insulation Boards).
- A rigid base is essential - Fixing WBP plywood or Warmup® Insulation Board to joists will not provide a suitable floor finish for accepting tiles.
- Refer to BS5385: Part 3: 1999, clause 14.4 for more information on sealing the backs and edges of the WBP plywood before fixing.
- The above recommendations apply to floors of small areas as advised in clause 14.4 of BS 5385: Part 3: 1999.

Concrete Subfloors

- Ensure you use an extruded polystyrene building or tile backer board (Warmup® Insulation Board) if installing your mat onto a cement-based floor.
- Fixing the board should be as per the manufacturer's instructions.

Testing the Heater

The heaters must be tested before, during and after tiling. We recommend the use of a digital multi-meter set to a range of 0-2 K ohms for testing. The resistance (ohms) of each mat should be measured. You should carry out the following tests and should expect the results detailed below:

- Live to neutral should show the Ohms value listed in the table on page 2. A +/- 5% Ohm reading tolerance is allowed under manufacturing guidelines. Record the readings on the control card at the back of the manual.
- Live to earth and neutral to earth should show infinity.

NOTE: Due to the high resistance of the heating element, it may not be possible to get a continuity reading from the mat and as such, continuity testers are not recommended. When checking resistance, make sure your hands do not touch the meter's probes as the measurement will include your internal body resistance and render the measurement inaccurate.

If you do not get the expected results or at any time you believe there may be a problem, please contact Warmup's Technical Team on 0845 345 2288 for guidance.

Floor Sensor

Ensure that the floor sensor is tested before the final floor finish has been laid. The floor sensor values can be found in the thermostat instructions. When testing the floor sensor ensure that the meter can read up to 20k ohms.

Electrical Safety Considerations

As with all electrical projects governed by Part P regulations, all mains electrical connections must be undertaken by a certified electrician. All work must conform to current IEE Wiring Regulations. The Underfloor heating must be controlled via a floor sensor thermostat at all times.

Installing a Residual Current Device (RCD)

Warmup® Underfloor Heating Mats must be wired via a 30mA RCD. You must install a dedicated RCD if one is not already present. You may wish to use a fused spur/RCD. No more than 4.8kW of heating may be connected to a single 30mA RCD.

NOTE: It is possible to run the heater from an existing circuit. Consult a certified electrician to determine whether or not the circuit can handle the load and if it is RCD protected.

Installing Electrical Boxes and Trunking

You will require a deep (35-40mm) back box for the thermostat. If you are installing more than two heaters, a junction box will be required. The wiring from the heater to the thermostat should be protected by conduit or plastic trunking.

Connecting the Thermostat

The thermostat must be connected to the mains electrical supply via a double pole isolator fused spur or RCD that has a contact separation in all poles providing full disconnection under over-voltage category III conditions. The thermostat should be installed within the room to be heated. In most bathroom installations the thermostat cannot be located within the bathroom itself as the thermostat is IP20 rated and must be located outside of Zone 2. In such cases the thermostat must be fitted to the outside of an internal wall of the bathroom, as close to the under floor installation as possible.

Warmup thermostats are rated up to 16 amps. For larger installations exceeding 16 amps multiple thermostats or a suitable contactor will be required. For further advice contact Warmup on 0845 345 2288.

Once the electrical connections have been made and the system has been tested, the electrician must complete the control card at the back of this installation manual. As per BS7671:2008 this information must be displayed at or near to the consumer unit.

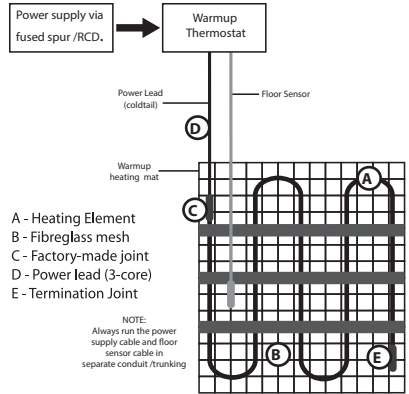

How You Can Modify the Mat

In order to fit your mat into a specific area, it may be necessary to cut and turn the mat (examples below).

NEVER cut the heating element. When cutting and flipping the mat take care not to cut or damage the heating cable.

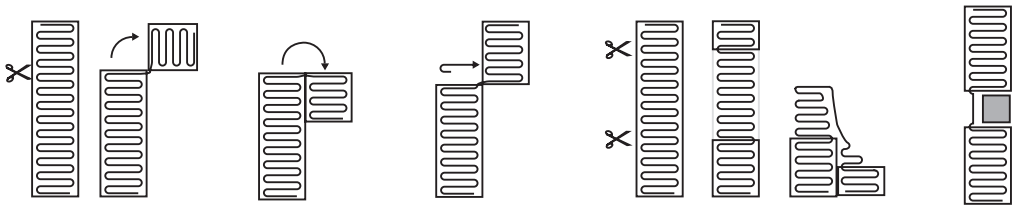

Check mat size

Please take a moment to double-check that your plan has the proper room dimensions and that you have the correct size and proper number of mats. Mats should run backwards and forwards between walls and obstructions as shown in the examples. Depending on insulation, air-flow & overall heat-loss within the room, additional heating may be required.

NOTE: When laying two or more heaters, ensure the coldtails reach the thermostat.

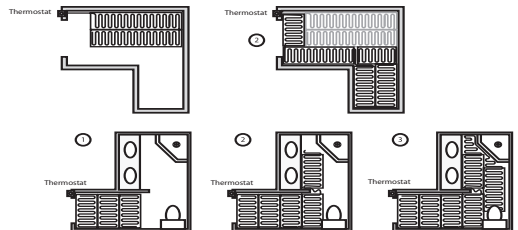

Installing the Mat

Step 1 - Mark the subfloor

Ensure that the subfloor is of the same construction where you intend to lay the mat to ensure that the heater performs effectively. Warmup always recommend that insulation boards, such as Warmup® Insulation Boards (10mm recommended), are used to improve the efficiency of the mats.

Using a permanent marker, mark out areas on the subfloor where units and fixtures will be fitted. DO NOT install the mat in any of these areas. Start by laying the mat in the location closest to the thermostat. Mark the positions and planned route of the power lead cables as well as the floor sensor.

ALL MANUFACTURED JOINTS NEED TO BE PLACED ON THE FLOOR UNDER A FULL BED OF ADHESIVE AND TILES.

If you have awkward areas in the room the loose wire can be removed from the mat to fit these areas. When doing this ensure that you DO NOT let the heating element cross or touch. Ensure any loose wires are no closer than 50mm from each other, the wall or from any other wires still attached to the mesh. Loose wire taken from the mat can be secured to the floor using duct tape.

Step 2 - Test the Heater

Before installing the heating mat perform the same test as described on page 5 to ensure that the heater has not been damaged during planning.

Step 3 - Cut, turn and affix the mat

When you have marked the positions and planned the route of the mat on the floor, start laying the mat cutting and turning where the marks have been made, beginning at the location closest to the thermostat. Be careful and never cut the heating cable. Affix the mat to the floor using its self-adhesive mesh, or using the double sided tape on the mat.

Use duct tape to affix any loose wires which have been removed from the mat. Once the mat is fitted, ensure that there are no loose sections, paying close attention to the ends of the mats and any section which has been turned.

DO NOT TAPE OVER THE MANUFACTURED JOINTS OR FLOOR SENSOR TIP.

If you find that once the heater has been laid you have too much of the mat left over STOP, contact Warmup immediately on 0845 345 2288. Remember you must NEVER cut the heating element to fit an area or leave surplus mats behind units or fixtures.

If you are installing multiple mats in one room they should be connected in parallel.

Step 4 - After installation test

Perform the same test as in step 2. If at this stage you do not get the expected reading or you are getting an open circuit contact Warmup on 0845 345 2288.

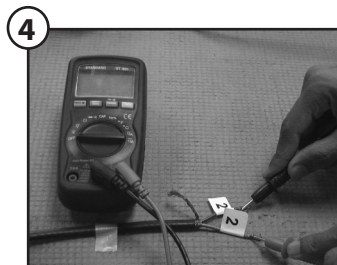
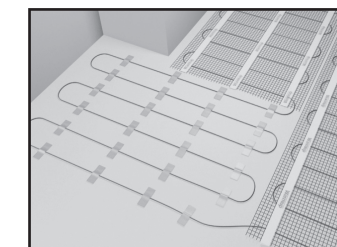
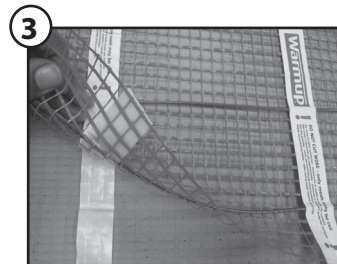
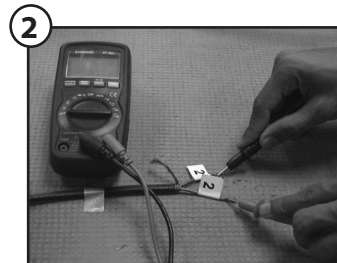
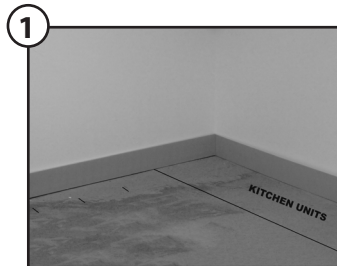

Installing the Mat (Continued)

Step 5 - Install floor sensor

Place the floor sensor below the fibreglass mesh. The floor sensor must be installed centrally between the two runs of heating element and should extend a minimum of 150mm into the heated area. Secure the sensor to the floor using tape.

NOTE: DO NOT TAPE OVER THE SENSOR TIP.

It is best to avoid placing the floor sensor in areas of heat fluctuations e.g. near hot water pipes or radiators. It may be necessary to cut a channel in the floor to ensure that the floor sensor and power supply cable are kept at the same height as the heating element.

When installing the floor sensor (located in the thermostat box) DO NOT cross over or under the heating element.

At this stage the floor sensor must also be tested. Check the resistance of the floor sensor using your multi-meter (20K ohms). You should get a reading of approximately 9-23K ohms depending on the room temperature. If you do not get a reading your floor sensor may be damaged. If this is the case call the Warmup Technical Helpline to request a replacement.

NOTE: The sensor may be extended up to 50m.

Step 6 - Fit Power Leads

Each mat is fitted with a single power lead for connecting the mat to the thermostat. To ensure the power lead remains at the same level as the heating element, you may need to cut or chisel a channel in the subfloor. When doing this take care not to damage the heating element. Secure the power lead in place using tape but do not tape over the manufactured joint where the power supply cable meets the heating element.

The power lead will go into the electrical trunking/conduit up to the thermostat. It is possible to extend the power lead using twin and earth cable.

NOTE: Instructions for fitting the Warmup® thermostat are included in the thermostat box.

Step 7 - Tile & grout the floor

Ensure you use tile adhesives and grouts suitable for use with underfloor heating systems (they must contain a flexible additive). It is important that each tile is solidly bedded in adhesive, with no air gaps or voids beneath. (2 Part Flexible Adhesive). Do NOT dot and dab the tiles. Check with the manufacturers of the adhesive to ensure suitability. Use a plastic notched trowel to move the adhesive along the element. Use a piece of cardboard on top of the exposed element to use as a crawl board. Ensure to test the resistance of the heating mat regularly during tiling to check the mat hasn't been damaged during tiling.

If using flexible levelling compound before tiling make sure that the mat is completely flat, extra tape can be used to secure the edges of the fibre glass mesh to the floor.

Do not store tiles or heavy objects on the mat while tiling. Wait for 8 days to allow the adhesive to dry before you switch on the system.

FINALLY TEST THE RESISTANCE OF THE HEATER(S) ONCE TILING IS COMPLETE.

5

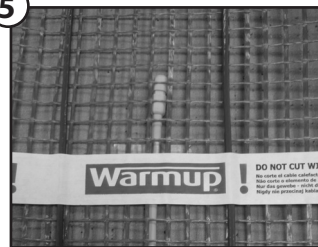

6

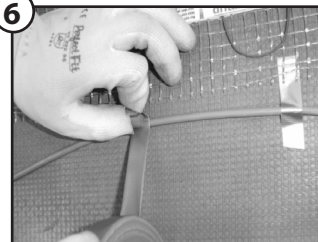

7



Warranty

Warmup[®]

The best underfloor heating - **guaranteed™**



Terms and conditions apply
Models: DWS heaters, PFM and SPM heaters manufactured by Warmup Plc.

THE LIFETIME ELEMENT OF THIS GUARANTEE DOES NOT EXTEND TO THERMOSTATS WHICH ARE COVERED BY SEPARATE GUARANTEES. THIS GUARANTEE DOES NOT AFFECT YOUR STATUTORY RIGHTS.

Warmup[®] Underfloor Heater is guaranteed by Warmup plc ("Warmup") to be free from defects in materials and workmanship under normal use and maintenance, and is guaranteed to remain so subject to the limitations and conditions described below. The UNDERTILE HEATER is guaranteed for the LIFETIME of the floor covering under which it is fitted, except as provided below (and your attention is drawn to the exclusions listed at the end of this guarantee).

This lifetime guarantee applies:

1. only if the unit is registered with Warmup within 30 days after purchase. Registration can be completed online at www.warmup.co.uk. In the event of a claim, proof of purchase is required, so keep your invoice and receipt - such invoice and receipt should state the exact model that has been purchased; and
2. only if the heater has been earthed and protected by a Residual Current Device (RCD) at all times.

Thermostats are guaranteed for a period of 3 YEARS from the date of purchase, except as provided below. The guarantee for the Warmup 3le thermostat can be upgraded to lifetime. Contact Warmup for details 0845 345 2288.

Neither guarantee continues if the floor covering over the heater(s) is damaged, lifted, replaced, repaired or covered with subsequent layers of flooring. The guarantee period begins on the date of purchase. During the period of the guarantee Warmup will arrange for the heater to be repaired or (at its discretion) have parts replaced free of charge. The cost of the repair or replacement is your only remedy under this guarantee which does not affect your statutory rights.

Such cost does not extend to any cost other than direct cost of repair or replacement by Warmup and does not extend to costs of relaying, replacing or repairing any floor covering or floor.

If the heater fails due to damage caused during installation or tiling, this guarantee does not apply. It is therefore important to check that the heater is working (as specified in the installation manual) prior to tiling.

WARMUP PLC SHALL IN NO EVENT BE LIABLE FOR INCIDENTAL OR CONSEQUENTIAL DAMAGES, INCLUDING BUT NOT LIMITED TO EXTRA UTILITY EXPENSES OR DAMAGES TO PROPERTY.

WARMUP PLC is not responsible for:

1. Damage or repairs required as a consequence of faulty installation or application.
2. Damage as a result of floods, fires, winds, lightning, accidents, corrosive atmosphere or other conditions beyond the control of Warmup plc.
3. Use of components or accessories not compatible with this unit.
4. Products installed outside the United Kingdom.
5. Normal maintenance as described in the installation and operating manual, such as cleaning thermostat.
6. Parts not supplied or designated by Warmup.
7. Damage or repairs required as a result of any improper use, maintenance, operation or servicing.
8. Failure to start due to interruption and/or inadequate electrical service.
9. Any damage caused by frozen or broken water pipes in the event of equipment failure.
10. Changes in the appearance of the product that does not affect its performance.



SafetyNetTM Installation Guidelines: If you make a mistake and damage the new heater before laying the floor covering, return the damaged heater to Warmup within in 30 days along with your original dated sales receipt. WARMUP WILL REPLACE ANY PRE-TILED HEATER (MAXIMUM 1 HEATER) WITH ANOTHER HEATER OF THE SAME MAKE AND MODEL - FREE.

Please note:

- (i) Repaired heaters carry a 5 year warranty only. Under no circumstances is Warmup responsible for the repair or replacement of any tiles / floor covering which may be removed or damaged in order to affect the repair.
- (ii) The SafetyNet[™] Installation Guarantee does not cover any other type of damage, misuse or improper installation due to improper adhesive or subfloor conditions. Limit of one free replacement heater per customer or installer.
- (iii) Damage to the heater that occurs after tiling, such as lifting a damaged tile once it has set, or subfloor movement causing floor damage, is not covered by the SafetyNet[™] Guarantee.

Register your Warmup[®] warranty online at www.warmup.co.uk

Control Card

Warmup[®]

The best underfloor heating - **guaranteed**[™]

Heater Location _____

Total Wattage _____

CAUTION
 Radiant Floor Heating Systems
 Warning-Risk of electric shock
 Electric-wiring and heating panels
 contained below the floor. Do not
 penetrate with nails, screws, or similar
 devices. Do not restrict the thermal
 emission of the heated floor.



Attention:

Do not cut or shorten the heating element.

Ensure that the entire heating elements including the joints are installed under the tiles in the installation.

The Heating element must be used in conjunction with a 30mA RCD.

Heater Model	Resistance Before	Resistance After	Insulation Resistance Pass	Floor sensor resistance

_____ Date

_____ Signed

_____ Company stamp/name

This form must be completed as part of the Warmup Guarantee. Ensure that the values are as per the instruction manual.

This card must be situated close to the consumer unit in a visible place.

Note: Draw a Plan showing the layout of the heater.

Warmup Plc 702 Tudor Estate Abbey Road London NW10 7UW T: 0845 345 2288 F: 0845 345 2299 www.warmup.co.uk



The best underfloor heating - **guaranteed**[®]

Documentation of Ownership, Installation & Part P Electrical Connection

This form must be filled out completely, otherwise you may invalidate your warranty

.....
Owner's Name

.....
Owner's Address

.....
Post Code Telephone

.....
Email

.....
Installer's Name

.....
Installer's Telephone Number

I hereby confirm that I have read & understand the contents of the installation manual & that the heater(s) has been installed as specified therein. I acknowledge that no claim can be brought against the manufacturer or its agents for any consequential loss or damage whatsoever. I confirm that the heater(s) was working prior to tiling.

.....
Installer's Signature Date

.....
Electrician's Name

.....
Electrician's Address

.....
Electrician's Telephone Number

.....
Electrician's Part P Certificate Number

**Warmup plc., United Kingdom
702 & 704 Tudor Estate
Abbey Road, London
NW10 7UW**

**Web:www.warmup.co.uk
Email:uk@warmup.com**

**Tel:0845 345 2288
Fax:0845 345 2299**

Warmup

Heated Towel Rails

Installation Manual



Technical Helpline
0345 345 2288

IMPORTANT!

Please read this manual before attempting to install your Warmup product. Complete and submit your warranty form online at www.warmup.co.uk



www.warmup.co.uk

Warmup®

The world's **best-selling** floor heating brand™

**Over 2 million installations in
more than 60 countries**

Experience **MyHeating™**

Download now for iOS and Android



Unique to Warmup:



SmartGeo™

Smarter geo-fencing.
Reduce energy usage
by up to 25%



EasySwitch™

Always on the best
tariff, automatically



Easy to use

Simple and secure
set up with 24/7
support

Natural Language Programming™

Programming that speaks your language



4iE® SMART WIFI
THERMOSTAT



Please scan the QR code
for more information

Components Required for Installation.....	4
Do's & Don'ts	5
Step 1 - Electrical Supply	6
Step 2 - Layout Planning	7
Step 3 - Mounting the Rails (Ladder)	8
Mounting the Rails (Single bar)	12
Step 4 - Make Electrical Connection	14
Troubleshooting.....	15
How to test the Towel Rail.....	16
Warranty	17
Control Card	18
Technical Specifications	19

WARNING!

Your Warmup® heated towel rail has been designed so that installation is quick and straight forward, but as with all electrical systems, certain procedures must be strictly followed. Warmup plc, accepts no liability, expressed or implied, for any loss or consequential damage suffered as a result of installations which in any way contravene the instructions that follow.

It is important that before, during and after installation that all requirements are met and understood. If the instructions are followed, you should have no problems. If you require help at any stage, please contact our helpline.

You may also find a copy of this manual and other helpful information on our website:

www.warmup.co.uk



Components available from Warmup

Ladder Rails



Warmup Heated Towel Rail and Components

- HTR-4ROPO • HTR-4SQPO
- HTR-6ROPO • HTR-6SQPO
- HTR-8ROPO • HTR-8SQPO

Single Bar Rails

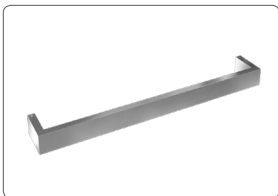

Warmup Heated Towel Rail and Components

- HTR-1ROPO • HTR-1SQPO
- HTR-1ROBR • HTR-1SQBR
- HTR-1ROBL • HTR-1SQBL

Additional components needed as part of your Warmup heating installation:

- 30 mA Residual Current Device (RCD), required as part of all installations.
- Digital Multi-meter required for testing the resistance of the heated towel rails.
- Measuring tape.
- Electrical housing, back boxes and junction boxes.
- Hammer.
- Masking tape.
- Spirit level.

 DO

- Install the Warmup Heated Towel Rails in line with these instructions. The towel rail is designed to warm towels only and not provide primary heating.
- Ensure that the control card at the back of the manual is completed and fixed at the consumer unit along with any plans and electrical test records as per the current edition of BS 7671.
- Install the towel rail at least 600 mm above the floor in order to avoid a hazard for very young children.
- Ensure that all electrical connections conform to the current BS 7671 Wiring Regulations. Final connections to the main electricity supply **MUST** be completed by a Part P qualified electrician.
- Ensure that the power supply to the towel rail is isolated before any installation or maintenance.

 DON'T

- Attempt a DIY repair if you damage the heated towel rail, contact Warmup for assistance.
- Pull on the power supply cable as it may cause damage to the towel rail.
- Attempt cleaning the towel rails using abrasive or chemical cleaners as these will damage the surface finish over time, use a soft clean cloth and a non abrasive cleaning agent.

WARNING: This appliance can be used by children aged from 8 years and above and persons with reduced physical, sensory or mental capabilities or lack of experience and knowledge if they have been given supervision or instruction concerning use of the appliance in a safe way and understand the hazards involved. Children shall not play with the appliance. Cleaning and user maintenance shall not be made by children without supervision.



Zone Chart



Install the RCD

Install a dedicated 30 mA RCD or use an existing RCD. No more than 7.5 kW of heating may be connected to each 30 milliamp RCD. For larger loads, use multiple RCD's.

NOTE: In the case of bathroom installations, electrical regulations prohibit the installation of Mains Voltage products such as thermostats, contactors, fused spurs, isolators or junction boxes, within Zones 0 or 1.

Warmup Heated Towel Rails have an IP rating of IP55 and are suitable for installation within Zone 1, Zone 2, Zone 3 or outside of any Zones.

All electrical connections must conform to the current BS 7671 Wiring Regulations. Final connections to the main electricity supply MUST be completed by a Part P qualified electrician.

Before you begin

In order to avoid a hazard for very young children, heated towel rails should be installed so that the lowest heated rail is at least 600 mm above the floor.



IMPORTANT: DO NOT mount towel rails to plasterboard alone as they will not provide enough support.

- Ensure that the wall you intend to mount the rails onto is strong enough to hold the weight of the towel rail.
- When you intend to mount the rails to stud walls, fixings must be made into the studs or noggins.

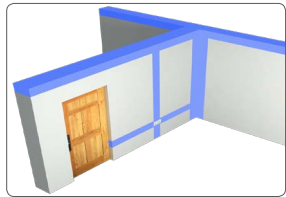
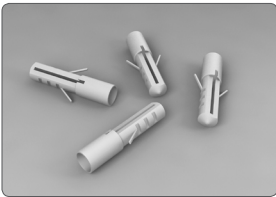

- When you intend to mount the rails to masonry walls use the wall plugs supplied.
- Cables back boxes etc., will have to be chased into masonry walls.
- Mains voltage cables installed within a wall must be fixed at least 50 mm from the wall surface or occupy the horizontal and vertical safe zones in accordance with BS 7671.

STEP 3 - MOUNTING THE RAIL LADDER RAILS



Components List



1A
Normal
Leg
x 3



1B
Exposed
Wiring Leg
x 1



1C
Concealed
Wiring Leg
x 1



2
M5 x 4
Grub screws
x 4



3
M5 x 6
Grub screws
x 4



4
Wall plugs
x 4



5
Mounting
Screws
x 4



6
Wall
Mount
x 3



7
Concealed Wiring
Wall Mount
x 1



8
Exposed Wiring
Wall Mount
x 1



9
Hex key
x 1



10
Short screws
x 4

Warmup's Ladder Towel Rails can be installed with either concealed or exposed wiring. The instructions below concentrate on concealed wiring.

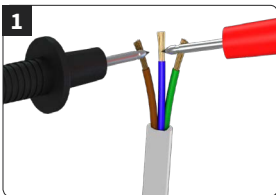

- Measure and record the resistance of the towel rails in the "Resistance Before" column of the control card, supplied as part of this installation guide.
- Stop installation immediately and contact Warmup if its resistance falls outside the values set out in the resistance table.

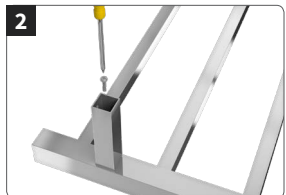

- Using a long screwdriver, screw the short screw (**10**) through the leg (**1A**) securing it to the towel rail body.

NOTE: The grub screw (**3**) should face the floor when the towel rail is mounted on the wall.

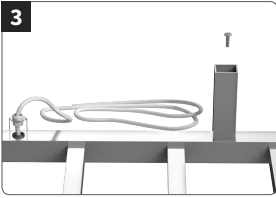

- Install the remaining 2 legs **(1A)** to the towel rail body as shown in Step 2.



- Attach the final leg **(1B or 1C)**, for exposed or concealed wiring, to the towel rail body using the grub screws **(2)** as shown.

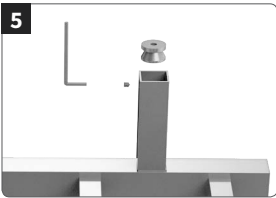

- With all 4 legs secured to the towel rail body, install the wall mounts **(6)** into each leg using the grub screws **(3)**.
- Install the concealed wiring wall mount **(7)** or exposed wiring wall mount **(8)**.

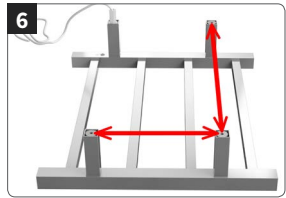

- Use a tape measure to measure the centre to centre distances between the wall mounts **(6)** which are secured in each leg and concealed **(7)** or exposed wiring **(8)** wall mounts.



- Mark the measurements taken in the previous step on the wall of your intended towel rail location keeping in mind that the lowest rail should be at least 600 mm above the floor level.
- Ensure the markings on the wall are level.



- Drill 3 holes in the wall for each of the 3 x wall mounts **(6)**.

NOTE: For exposed wiring drill a 4th hole of equal size.

For masonry walls gently tap wall plugs **(4)** into the holes using a hammer.

STEP 3 - MOUNTING THE RAIL LADDER RAILS

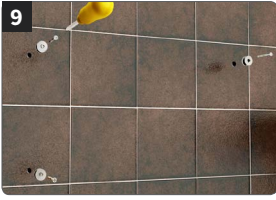

- Remove the wall mounts x 3 **(6)** from the legs **(1A)**.
- Insert the mounting screws **(5)** through the wall mounts and secure to the wall as shown ensuring that they sit flush with the wall.

NOTE: For exposed wiring, install exposed wiring wall mount **(8)**.

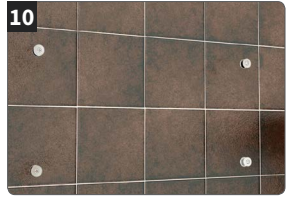

- Drill a larger 4th hole for the concealed wiring leg.
- Remove the concealed wiring wall mount **(7)** from the leg **(1C)**.
- Apply grab adhesive to the wall mount thread and press into the drilled hole until it sits flush with the wall.

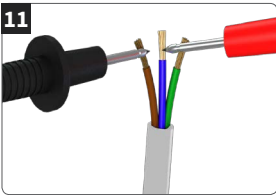

- Conduct another resistance test before mounting the towel rail to ensure it has not been damaged and record in the control card.



- Position the rail against the wall and insert the power supply cable through the concealed wiring wall mount **(7)**.
- Place the rail onto the wall mounts **(6)** and secure by tightening the grub screws **(3)** as shown.



STEP 3 - MOUNTING THE RAIL

SINGLE BAR RAILS



Components List



1A
Wall mounts
(Round Rails)
x 2



1B
Wall mounts
(Square Rails)
x 2



2
M5 x 8
Grub screws
x 2



3
Wall plugs
x 3



4
Mounting
Screws
x 3



5
Hex key
x 1

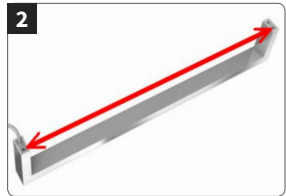
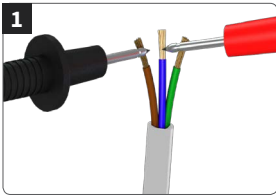

- Measure and record the resistance of the towel rails in the “Resistance Before” column of the control card, supplied as part of this installation guide.
- Stop installation immediately and contact Warmup if its resistance falls outside the values set out in the resistance table.
- Place the wall mounts (**1A or 1B**) into the rail. Use a tape measure to measure the distance between the screw holes on the wall mounts.
- Also measure the distance between the screw and power supply cable holes.

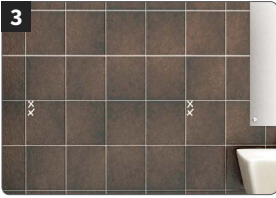

- Mark the screw and power supply cable hole positions on the wall you intend to mount the rail using measurements taken in Step 2. Ensure the markings are level.

NOTE: The supply cable mount should be on the right hand side.



- Drill three holes into the previously marked positions, two for the mounting screws and one for the supply cable

NOTE: For masonry walls gently tap wall plugs (3) into the mounting holes using a hammer.

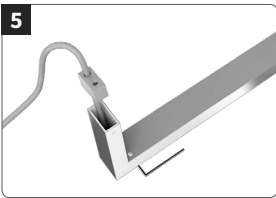

- Remove the wall mounts (1A or 1B) from the towel rail by unscrewing the grub screw (2) located at the bottom of the rail.

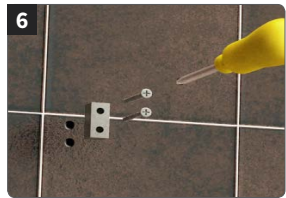

- Insert the mounting screws (4) through the wall mounts (1A or B) and screw into the wall.

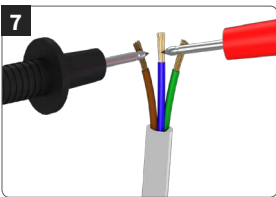

- Conduct another resistance test before mounting the towel rail to ensure it has not been damaged and record in the control card.



- Position the rail against the wall and thread the power supply cable through the wall mount (1A or 1B).
- Secure the rail onto the wall mounts by tightening the grub screws (2) using the hex key (5) as shown.

STEP 4 - MAKE ELECTRICAL CONNECTION



The Warmup Heated Towel Rails electrical connection must conform to the current BS 7671 Wiring Regulations. Final connections to the main electricity supply **MUST** be completed by a Part P qualified electrician.



- The supply should be on a circuit protected by a maximum 5 amp fuse or circuit breaker. It is recommended that the heated towel rails supply is fitted with an in-line isolator to allow it to be independently isolated. Please see Page 6 for correct zoning.

Warmup Heated Towel Rails can be connected into the rooms lighting circuit, enabling the towel rail when the lights are switched on.

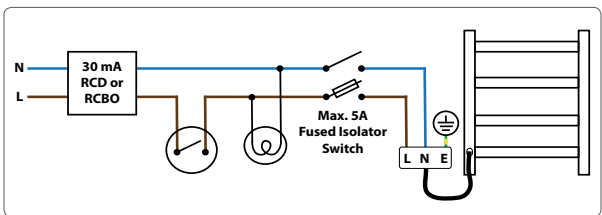

Alternatively they can be controlled by an independent controller that provides power on demand.

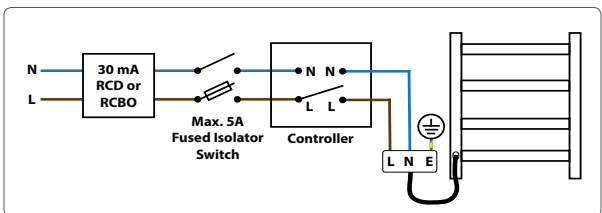

Instructions which are shaded must be completed by a qualified electrician.

HEATING ISSUE 1 - The towel rail does not heat up.

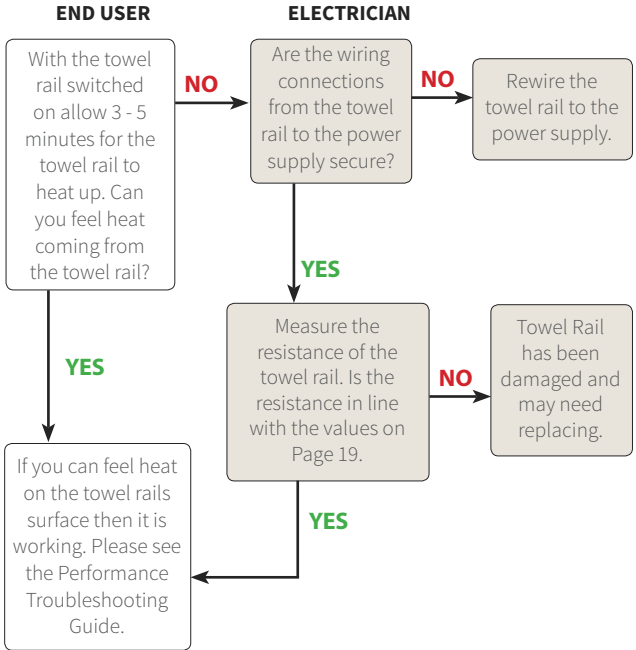

HEATING ISSUE 2 - The towel rail trips the RCD

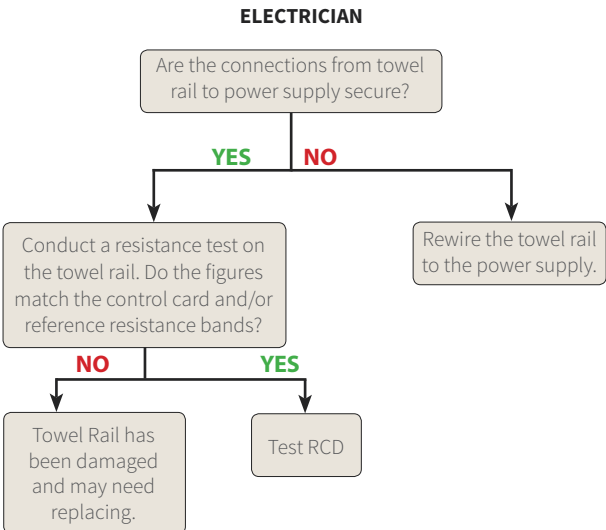



The heated towel rails must be tested before they are installed and again before final connection is made. The resistance (ohms) of each heater should be measured. You should carry out the following tests and should expect the results detailed below:

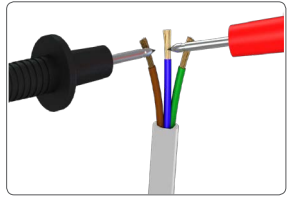

• **Heated Towel Rail Resistance Test**

Set a multimeter or ohmmeter to record resistance in the range of the heated towel rail. Measure the resistance across the live (brown) and neutral (blue) wires. Ensure the measured resistance is in line with Resistance values for the rail being tested.

Record the readings on the control card in line with the installation procedure.

• **Earth Fault Check**

Set a multimeter or ohmmeter to record resistance in the range of $1M\Omega$ or greater if available. Measure the resistance across the live (brown) and neutral (blue) wires to the earth (green/yellow) wire.

Ensure the measured resistance is showing as greater than $500M\Omega$ or infinite if the meter cannot read this high.

Insulation resistance test

Set an insulation resistance tester to 500VDC. Measure the resistance across the live (brown) and neutral (blue) wires to the earth (green/yellow) wire. Ensure the measured resistance is showing greater than $500M\Omega$ to indicate a pass.

Warmup® Heated Towel Rails are guaranteed by Warmup plc ("Warmup") to be free from defects in materials and workmanship under normal use and maintenance, and is guaranteed to remain so subject to the limitations and conditions described below. The Heated Towel Rail is guaranteed for 5 years, except as provided below (and your attention is drawn to the exclusions listed at the end of this guarantee).



This 5 year guarantee applies:

1. Only if the unit is registered with Warmup within 30 days after purchase. Registration can be completed online at www.warmup.co.uk. In the event of a claim, proof of purchase is required, so keep your invoice and receipt - such invoice and receipt should state the exact model that has been purchased;

&

2. Only if the towel rail has been earthed and protected by a Residual Current Device (RCD) at all times.

The guarantee period begins on the date of purchase. During the period of the guarantee Warmup will arrange for the heater to be repaired or (at its discretion) have parts replaced free of charge. The cost of the repair or replacement is your only remedy under this guarantee which does not affect your statutory rights.

Such cost does not extend to any cost other than direct cost of repair or replacement by Warmup and does not extend to costs of refacing, replacing or repairing any wall covering or walls. If the heater fails due to damage caused during installation or through misuse, this guarantee does not apply. It is therefore important to check that the heater is working (as specified in the installation manual) prior to installing.

WARMUP PLC SHALL IN NO EVENT BE LIABLE FOR INCIDENTAL OR CONSEQUENTIAL DAMAGES, INCLUDING BUT NOT LIMITED TO EXTRA UTILITY EXPENSES OR DAMAGES TO PROPERTY.

WARMUP PLC is not responsible for:

1. Damage or repairs required as a consequence of faulty installation or application.
2. Damage as a result of floods, fires, winds, lightning, accidents, corrosive atmosphere or other conditions beyond the control of Warmup plc.
3. Use of components or accessories not compatible with this unit.
4. Products installed outside the United Kingdom.
5. Normal maintenance as described in the installation and operating manual, such as cleaning.
6. Parts not supplied or designated by Warmup.
7. Damage or repairs required as a result of any improper use, maintenance, operation or servicing.
8. Failure to start due to interruption and/or inadequate electrical service.
9. Any damage caused by frozen or broken water pipes in the event of equipment failure.
10. Changes in the appearance of the product that does not affect its performance.

**Register your Warmup® warranty online at
www.warmup.co.uk**



Heater Location

.....

.....

Total Wattage

.....

WARNING

Heated Towel Rail wiring located behind wall. Risk of electric shock!

DO NOT penetrate the wall with nails, screws, or similar devices in this towel rails location.

Heated Towel Rail Model	Resistance Before	Resistance After	Insulation Resistance

.....

Date

Signed

Company stamp/name

This form must be completed as part of the Warmup Guarantee. Ensure that the values are as per the instruction manual.

This card must be situated close to the consumer unit in a visible place.

Warmup Plc 702 & 704 Tudor Estate Abbey Road
London NW10 7UW

T: 0345 345 2288 F: 0345 345 2299 www.warmup.co.uk



TECHNICAL SPECIFICATIONS - Heated Towel Rails	
OPERATING VOLTAGE	230 V AC : 50 Hz
IP RATING	IP55
ELECTRICAL CLASS	Class I
CONNECTION	1.5 m LONG "COLDTAIL" CONNECTION

Heated Towel Rail Size Guide

Ladder Rails				
PRODUCT CODE	SIZE (mm)	POWER (W)	LOAD (A)	RESISTANCE +/- 10 % (Ω)
HTR-4ROPO	4 Bar Ladder - Round Polished 520(h) x 500(l) x 120(d) mm	52	0.23	1017
HTR-4SQPO	4 Bar Ladder - Square Polished 435(h) x 525(l) x 120(d) mm	52	0.23	1017
HTR-6ROPO	6 Bar Ladder - Round Polished 600(h) x 650(l) x 120(d) mm	90	0.39	588
HTR-6SQPO	6 Bar Ladder - Square Polished 600(h) x 650(l) x 120(d) mm	95	0.41	557
HTR-8ROPO	8 Bar Ladder - Round Polished 800(h) x 530(l) x 135(d) mm	100	0.43	529
HTR-8SQPO	8 Bar Ladder - Square Polished 912(h) x 620(l) x 120(d) mm	115	0.50	460

Single Bar Rails				
PRODUCT CODE	SIZE (mm)	POWER (W)	LOAD (A)	RESISTANCE +/- 10 % (Ω)
HTR-1ROPO	Single Bar - Round Polished 32(h) x 650(l) x 100(d) mm	19	0.08	2800
HTR-1SQPO	Single Bar - Square Polished 40(h) x 650(l) x 100(d) mm	19	0.08	2800
HTR-1ROBR	Single Bar - Round Brushed 32(h) x 650(l) x 100(d) mm	19	0.08	2800
HTR-1SQBR	Single Bar - Square Brushed 40(h) x 650(l) x 100(d) mm	19	0.08	2800
HTR-1ROBL	Single Bar - Round Black 32(h) x 650(l) x 100(d) mm	19	0.08	2800
HTR-1SQBL	Single Bar - Square Black 40(h) x 650(l) x 100(d) mm	19	0.08	2800

Warmup plc

United Kingdom
702 & 704 Tudor Estate
Abbey Road, London
NW10 7UW

Web: www.warmup.co.uk

Email: uk@warmup.com

Tel: 0345 345 2288

Fax: 0345 345 2299

The WARMUP word and associated logos are trade marks.

© Warmup Plc. 2019 – Regd. TM Nos. 1257724, 4409934, 4409926,
5265707. E & OE.



Bathroom
Heating

www.warmup.co.uk

Installation Guide:

for the Warmup **Tempo** Digital Programmable Thermostat
Part of the Element Series

Warmup[®]

The world's **best-selling** floor heating brand™

Introduction

The **Tempo** thermostat is designed to aid in the comfort of your home by providing timed regulation of your Warmup underfloor heating system. The thermostat is designed to receive temperature input signals from the following sensors:

1. Air sensor located inside the thermostat
2. Floor sensor installed in the floor to be heated (see Warmup heater instructions for details)

The thermostat is not a safety device and should only be used with Warmup heating products. In order to avoid damaging your flooring the correct floor type must be selected during the thermostat programming process.

Electrical Specification:

- Supply voltage: 230V +/-15% at 50Hz
- Thermostat is not designed for use with intermittent power supply.
- Maximum Switch Load: 16A resistive
- Insulation Class : II
- Housing : IP20
- Sensor NTC : 10K @ 25°C
- Standards: EN60730-1 & EN60730-2-9
- Meets LVD and EMC directives for safety and electromagnetic compatibility

WARNING – Important safety note

This product uses mains voltage electricity and work should only be carried out by a qualified electrician. You should always isolate the power supply before attempting to install or repair the **Tempo** thermostat. The thermostat should not be put into operation unless you are certain that the entire heating installation complies with current general safety requirements for electrical installations. Electrical installation must be in accordance with the latest IEE Wiring Regulations and appropriate Statutory Regulations.

Thermostat location

The thermostat should be installed inside a single gang electrical wall box that is at least 32mm deep. For optimal performance, the thermostat should be located in an area with good ventilation. It should not be installed beside a drafty window/door, in direct sunlight or above another heat generating device (e.g. Radiator or TV).

The thermostat is designed for operation between 0°C and 50°C with relative humidity less than 80%.

Location and installation of floor sensor

The optimum location of the floor sensor is described in each Warmup heater installation manual. Refer to that manual when selecting floor sensor location.

Warmup recommend the use of conduit when installing the floor sensor. The conduit will protect the sensor and will allow easier repair of the sensor in the case of sensor damage after flooring has been laid.

Installation:

Separate the front housing of thermostat from the wall module:

1. Unscrew both closing screws (bottom of thermostat) until they will not turn any further.
2. Release front housing by gripping the lower half of outer frame and pulling outwards then upwards.
3. Place front housing somewhere safe.
4. Run all wires to the wall box. Check to ensure that you have included the following:
 - Power (Live and Neutral)
 - Heater (Live and Neutral)
 - Floor sensor
 - Fil pilote (France only)
5. Pull wires through the wall box and complete terminal wiring.

IMPORTANT: Ensure that multi strand wires are fully inserted into the terminal and secured tightly. **Any loose strands should be trimmed as they could cause a short-circuit.**

If connecting more than two heaters, an electrical junction box will be required.

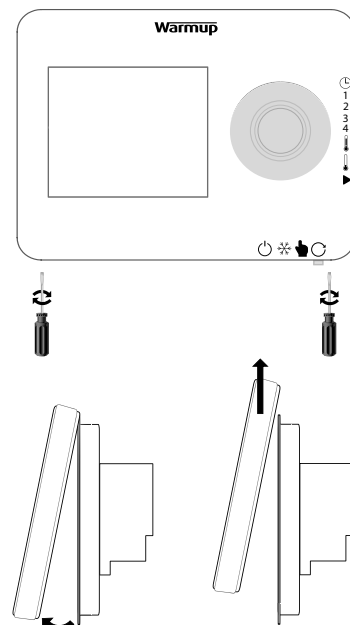

Normal electrical installation (see numbering on diagram to right)

1. Connect to Fil Pilote (F.P.) - only for use in France
2. Connect to Power Supply (Live – MAX 240V)
3. Connect to Power Supply (Neutral – MAX 240V)
4. Connect to Warmup heater(s) (Neutral – MAX 3600W/ 16 Amps)
5. Connect to Warmup heater(s) (Live – MAX 3600W/ 16 Amps)
6. Not Used
7. Connect to 1st wire of floor sensor (colour not important)
8. Connect to 2nd wire of floor sensor (colour not important)

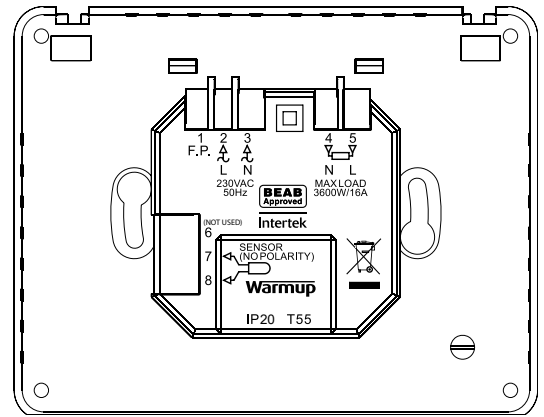

Mounting thermostat into the wall box

1. Push excess wire back through the wall box and insert thermostat back module into wall box.
2. Put fixing screws through mounting holes and tighten.
3. Ensure that thermostat is straight before tightening completely.
4. Replace thermostat front housing:
 - Align and sit front housing on to hinges
 - Push lower half of front housing until a 'click' is heard.
5. Ensure front housing is securely fixed.
6. **IMPORTANT:** Tighten both retaining screws.

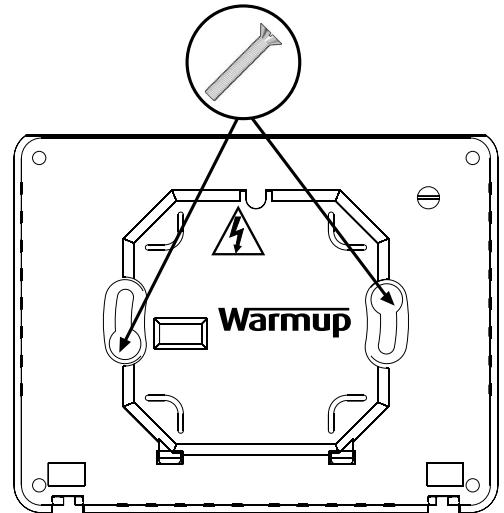

Powering-up

You can now power-up the thermostat and begin the programming process.

Contact Warmup

UK
Warmup Plc
702 & 704 Tudor Estate
Abbey Road
London
NW10 7UW

T: 0345 345 2288
International: + 44 208 453 6868
F: 0345 345 2299
E-mail: uk@warmup.com
Website: www.warmup.co.uk

Disposal

Appliances with this symbol must not be disposed of with general waste. Seek guidance from your local government or the retailer where you purchased the product.



Patent Pending

