

GEO Intense 4 in1 Hot Tap

Installation Guide

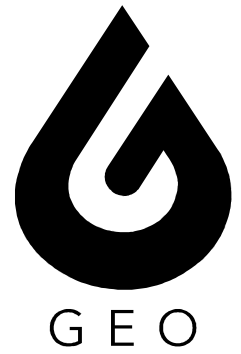

- ① Please read these instructions carefully before installation or use and retain for future reference.
- ① You must install the tap and filter before the boiler.

We have a policy of continued product and quality development and improvement. Accordingly we reserve the right to amend the specification at any time. All errors and omissions excepted.



An information point or tip for installation or usage.



A service, maintenance or care consideration.



A technical or safety consideration or warning of hazardous situation with regard to life and property.

Using the product

Thank you for choosing this product. Reading this guide will ensure that the product is used safely and will give its best performance.



WARNING: THIS APPLIANCE CAN BE USED BY CHILDREN AGED FROM 8 YEARS AND ABOVE AND PERSONS WITH REDUCED PHYSICAL, SENSORY OR MENTAL CAPABILITIES OR LACK OF EXPERIENCE AND KNOWLEDGE ONLY IF THEY HAVE BEEN GIVEN SUPERVISION OR INSTRUCTION CONCERNING USE OF THE APPLIANCE IN A SAFE WAY AND HAVE UNDERSTOOD THE HAZARDS INVOLVED. CHILDREN SHALL NOT PLAY WITH THE APPLIANCE. CLEANING AND USER MAINTENANCE SHALL NOT BE MADE BY CHILDREN. ALL WIRING AND INSTALLATION MUST BE SUPERVISED BY A SUITABLY QUALIFIED PERSON.



Please also fully read and understand the boiler user instructions before use.



It is normal for the hot water to take a moment to both dispense upon each use and stop fully after the handle is closed as water remains within the product.



The 98°C handle is also supplied with a red plastic safety clip which prevents the handle lock from opening when clipped under the operating lever.



Do not add to, exchange or modify any component of the boiler or mixer tap, only genuine parts must be used. The spout exit or any part of the system must not include any additional third-party adaptors, components or connections that will add resistance or modify the system.



The installation should be periodically checked for damage, if the property is left unattended for a prolonged period we recommend isolating water supplies and switching off the boiler at the mains socket. On reconnection flush thoroughly.



Clean the tap with a damp soft cloth and a mild dish soap to remove any grease marks created during installation as per the care instructions.



Each time the product is used you should flush a small amount of boiled water through before use, typically this can be used to preheat your cup, if unused for extended periods then flush the product a longer time.

Your tap can dispense 4 types of water:

- **Cold (filtered) water** – This is delivered when the left side handle is rotated backwards up to a maximum of apx. 45° (Fig 1).
- **Hot (boiled & filtered) water** Fully push the left side handle lever down (Fig 2.) and then simultaneously turn the handle forwards (Fig 3.), the further forwards the lever is turned the greater the flow up to a maximum of apx. 45°. It is normal for the hot water to take a moment to start and stop dispensing as the water empties from the product after use.
- **Hot & Cold (domestic) water** – Mixed water is delivered when the right-side handle is tilted right (Fig. 4). With the handle tilted Cold water is delivered when pushed backwards, and Hot is delivered when pulled forwards.

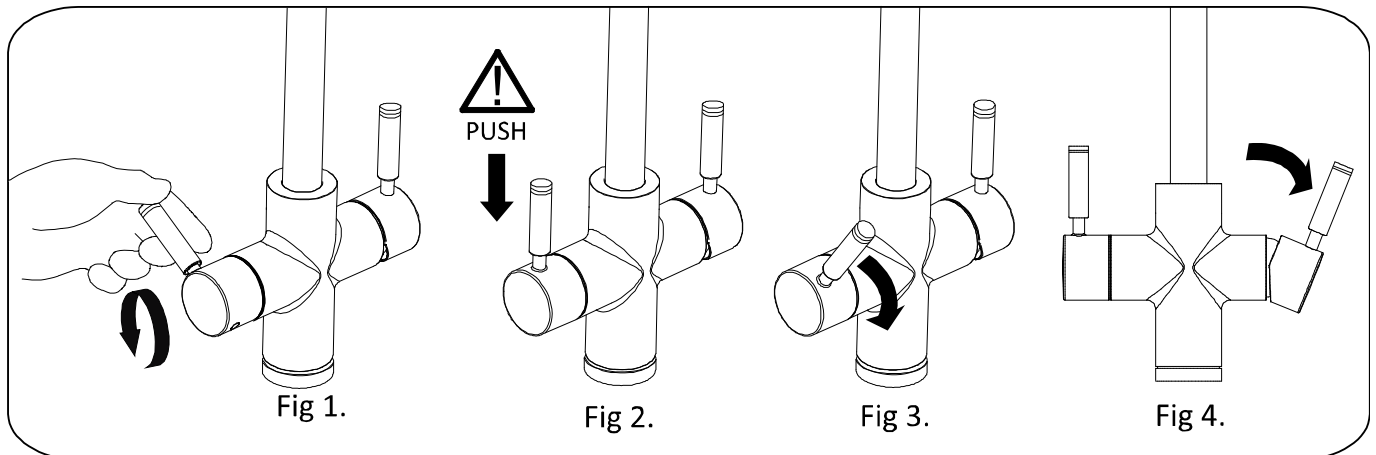

Care instructions for your kitchen tap mixer

To maintain the appearance of this tap, ensure that it is regularly cleaned only using a clean, soft damp cloth. A solution of warm water and a mild liquid detergent may be used where necessary, and then the fitting rinsed thoroughly and wiped dry. Any other cleaning action will invalidate your warranty.



Abrasive cleaners, scouring cleaners and acidic cleaners **must not be used** under any circumstances. Avoid contact with all solvents (including chlorinated solvents, ketones or acetones as these may result in surface deterioration or etching). Also avoid contact with any harsh household chemicals such as oven cleaners, drain cleaners, rust removers, paint strippers and toilet bowl cleaners, bar keepers friend or Brasso.



Where the tap has a removable aerator on the spout exit it can be removed and cleaned periodically to maintain optimum flow performance and remove any limescale, when reattaching please **ensure to reconnect the center stem of the aerator to the center spout flexible tube fully**.

5 Year Tap Warranty Terms and Conditions

In the unlikely event that you should experience any defect in the materials or workmanship of your new Rangemaster 4 in 1 hot mixer tap within FIVE years of purchase, the purchaser's sole remedy shall be the replacement (at the manufacturer's discretion) of all or any part of the product that is defective. All working parts and valves are guaranteed for a period of FIVE years from purchase. Decorative surface finishes and O-rings are guaranteed for FIVE years from the date of purchase provided that our advice concerning care has been observed and no scouring agents have been used.

This is provided that the mixer has been used for normal domestic purposes in the UK or Eire and that the care, installation and maintenance instructions have been observed. The warranty extends to the original purchaser only. You should retain a copy of your dated invoice as proof of purchase to validate any claims under this guarantee.

Marks, scuffs and scratches caused by improper installation or accidental damage are not covered by this guarantee. Neither are shade variations or any damage or defect caused by incorrect installation or abuse of the fitting.

As we are continuously improving and developing our range of products, finishes & colours, in the event of a valid claim, we may not be able to provide an identical replacement for the defective product throughout the guarantee period. Where an identical product is no longer available, we will supply the nearest equivalent from our then current product range. In assessing your claim, we must be given the opportunity to inspect the product as installed prior to removal. Any product returns must be packaged as received and complete.

No other warranties, express or implied, are made, including merchantability or fitness for a particular purpose. Under no circumstances shall the manufacturer be liable for any loss or damage arising from the purchase, use or inability to use this product, or for any special, indirect, incidental or consequential damages. No liability is accepted for consequential damage to other household fixtures, fittings or furnishings arising from this claim, even if attached to the product. No installer, dealer, agent or employee of Aga Rangemaster Limited has the authority to modify the obligations or limitations of this warranty.

For boiler warranty terms and conditions please see the separate user guide supplied.

Tap installation

Important Technical Data

Minimum operating pressure (hot): 0.5 bar	Minimum operating pressure (cold): 1.5 bar
Maximum operating pressure: 5.5 bar*	Maximum domestic hot water temperature: 70°C*
Flow characteristics: Domestic Hot, Cold & filtered cold share outer single flow spout. Boiled filtered water: Through centre spout channel.	Recommended domestic hot water Temperature: 46°C

 *If these temperatures or pressures are exceeded, even for short periods, damage can result. In these instances, a thermostatic mixing or pressure reducing valve should be installed.

 This product is manufactured in accordance with recognised European standards. Please ensure that your kitchen mixer is fitted in accordance with Local Water Byelaws. **Where hot and cold water mix within the tap, then suitable non return (check) valves should be installed to both the hot and cold supplies to prevent backflow**, a preinstalled non return valve on the cold supply flexi hose (F1) is already supplied (see instructions key).

 Hot and cold supply pressures should be as closely balanced as possible for best results. Supply pipes should maintain the maximum diameter until immediately before the fitting. The differential between the hot and cold water supply temperatures should be sufficient to allow correct mixing function.

 These installation guidelines have been prepared for your direction and you must exercise due care at all times. We do not accept responsibility for problems that may occur through improper installation. Whilst assembling the tap take care not to accidentally loosen any factory fixed assemblies.

This tap has been 100% assembly tested; therefore you may expect a small residual amount of water to remain in the tap when delivered. Any water marks can be removed using the care advice.

Installation Preparation

⚠️ You must install the mixertap and filter before the boiler.

⚠️ Before installing the new mixer it is essential that you thoroughly **flush through the supply pipes** in order to remove any remaining solder, swarf or impurities from your system. Failure to carry out this simple procedure could cause problems or damage to the workings of the mixertap or boiler.

🔧 We recommend installing particle filters (not shown) and isolation valves (G1) to both the hot and cold feed pipes in an accessible position. This will help to prevent premature failure of the valves and ease any future maintenance.

⚠️ Ensure you have suitable domestic hot and cold water pressure before installing this product (see technical data).

ℹ️ All parts should be removed from their packaging and inspected for any transport damage and completeness prior to installation.

ℹ️ Loosely position the tap, pipes and other principal supply components to check if any alterations to the existing supply pipework is required, if this is the case do this now.

⚠️ Shut off your water heating system and ensure that your mains stopcock is closed. Open the lowest hot and cold taps in the house and allow the water to run until fully stopped.

If replacing an existing tap, remove the tap & clean the end of the feed pipes using wire wool, the tap hole area should be free from dirt and sealant.

This mixertap requires a $\varnothing 35\text{mm}$ tap hole, as both handles rotate backwards and forwards you should allow for this distance "A" behind the tap when planning the sink and tap hole location as shown.

ℹ️ This tap is designed to be installed in a worktop with a maximum thickness of 45mm.

ℹ️ For this product "A" should be no less that 70mm (Tap hole centre to tiled wall or backsplash face)

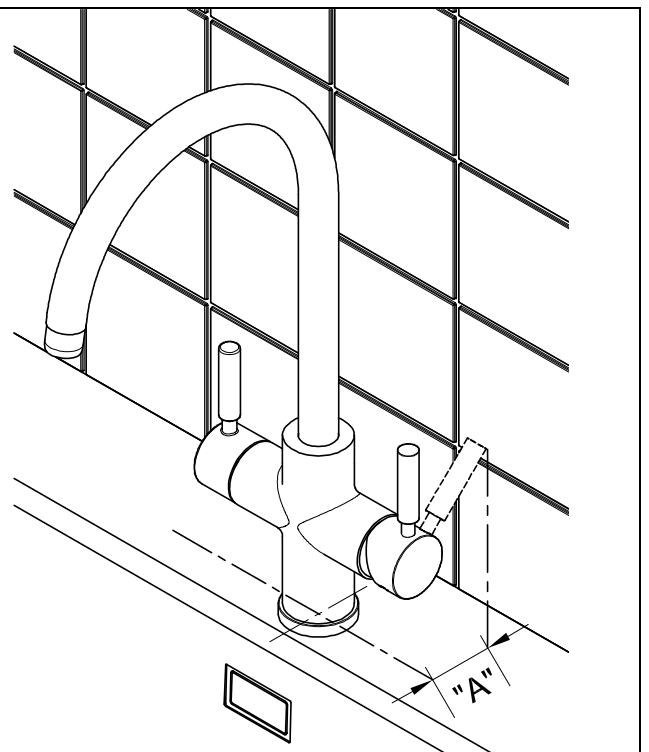

Parts and Contents

Key	Description	Qty
A1	Mixer tap	1
A2	Base plinth	1
A3	Base plinth seal	1
A4	Sink or worktop (max. 50mm)	0
A5	White triangular plate (for use with steel sinks only)	1
A6	Lower gasket	1
A7	Metal horseshoe	1
A8	Fixing stud	1
A9	Fixing nut	1
B1	Cold filtered (from tap to boiler) flexible hose (M8 x 3/8" F), includes captive seal	1
B2	3/8" M x 1/4" F brass adaptor	1
B3	1/4" NPT M x 1/4" pushfit	1
B4	1/4" outside diameter plastic pipe	1**
C1	Cold filtered (from filter to tap) blue banded flexible hose (M8 x 3/8" F), includes captive seal	1
C2	3/8" M x 1/4" F brass adaptor	1
C3	1/4" NPT M x 1/4" pushfit	1
C4	1/4" outside diameter plastic pipe	1**
C5	Filter bracket	1
C6	Filter bracket screw	1
C7	Filter cartridge	1
C8	1/4" outside diameter plastic pipe	1**
C9	3/4" BSPF x 1/4" pushfit adaptor	1
D1	Steaming hot water (from boiler to tap) "110" red labelled flexible hose. M8 x 3/8" F	1
D2	3/8" fibre seal	1
E1	Domestic hot in (from mains feed) red banded flexible hose M10 x 1/2" BSPM (15mm)	1
F1	Domestic cold in (from mains feed) blue banded flexible hose M10 x 1/2" BSPM (15mm)	1
F2	Non return valve (factory fitted into flexible hose F1)	1
F3	15mm olive	0
F4	15mm nut	0
F5	15mm pipe	0
G1	15mm isolation valve	0
G2	15mm olive	0
G3	15mm nut	0
G4	15mm pipe	0
G5	15mm nut	2
G6	15mm olive	2
G7	1/2" x 1/2" x 3/4" isolating tee valve	1

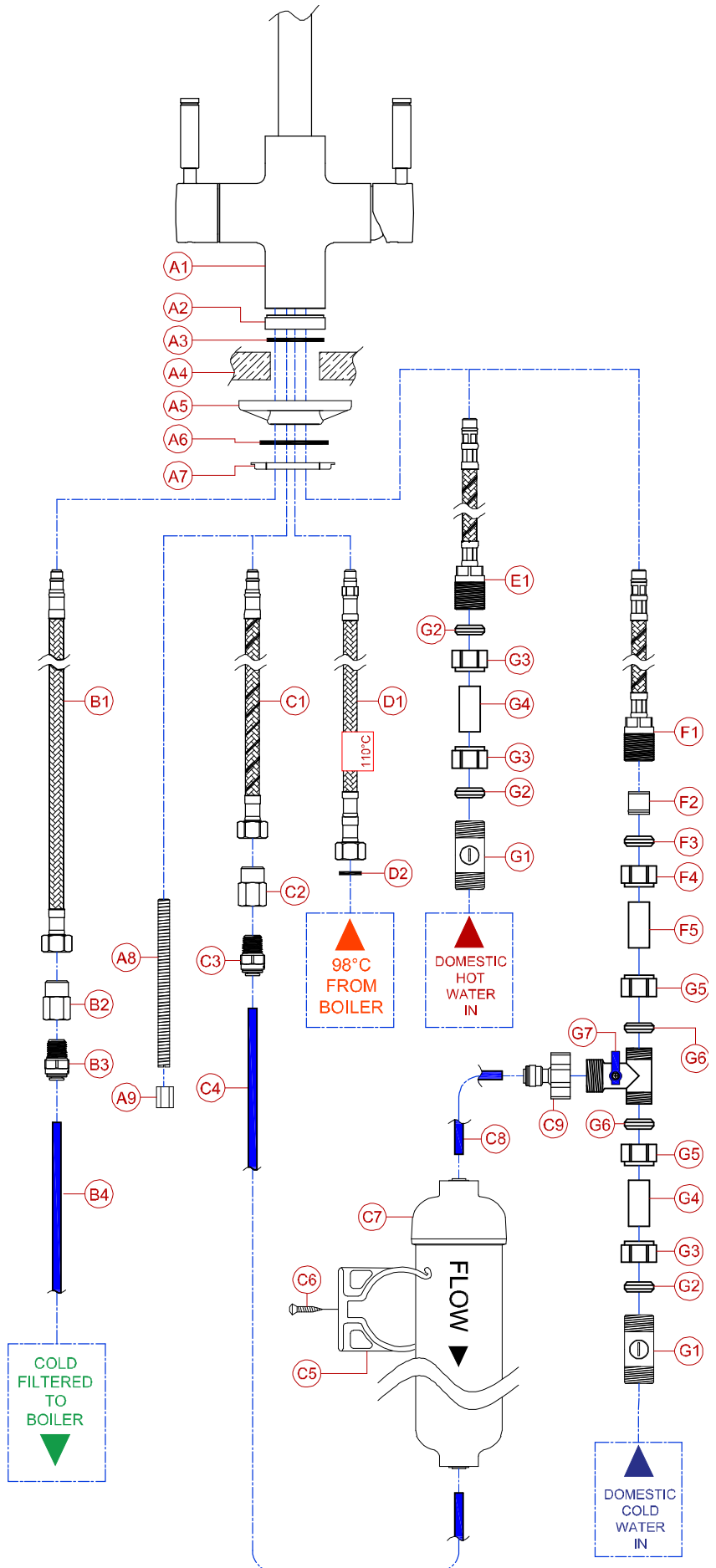

****Part supplied with boiler pack, cut to form required lengths to and from filter and boiler, for the boiler parts list and connections please refer to the instructions supplied with the boiler for more detail.**

Install the tap:

This diagram shows the view of the base of the tap (A1) with the 98°C water handle to the left of the body.

⚠ YOU MUST CAREFULLY ACKNOWLEDGE THE INLETS AND OUTLETS AS SHOWN

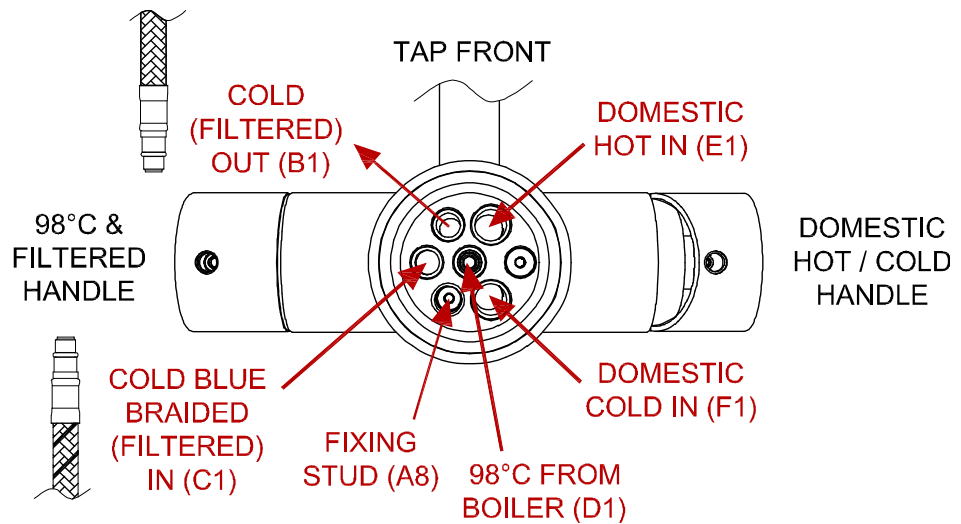

1. Screw the fixing stud (A8) into base of tap (A1) as shown on the diagram.
 2. Place the base plinth (A2) and base plinth seal (A3) onto the base of the tap (A1).
 3. Hand tighten the domestic hot in flexible hose (E1) as shown in the diagram.
 4. Hand tighten the domestic cold in flexible hose (F1) as shown in the diagram.
 5. Hand tighten the filtered cold in flexible hose (C1) as shown in the diagram.
 6. Hand tighten the filtered cold out flexible hose (B1) as shown in the diagram.
- ⚠ TAKE CARE NOT TO INVERT (C1) & (B1). DOING SO WILL RESULT IN NO FILTERED WATER**
7. Hand tighten the 110° rated steaming hot flexible hose (D1) into the centre inlet as shown on the diagram.
 8. Place the tap (A1-A3) centrally and straight to the tap hole, passing the fixing stud (A8), flexi hoses (B1, C1, D1, E1 & F1) through the tap hole.
 9. Pass the lower gasket (A6) then the metal horseshoe (A7) over the fixing stud (A8). Note: only if the tap is to be fitted to a stainless steel sink then the white triangular plate (A5) can be fitted where shown to improve the stability of the tap.
 10. Using a 13mm box spanner or small adjustable spanner tighten fixing nut (A9) onto the fixing stud (A8).
 11. Screw pushfit (B3) into brass adaptor (B2) and pushfit (C3) into brass adaptor (C2)
- ⚠ We recommend using PTFE tape (do not use sealing compound) on the thread of the pushfit fittings to make a good seal without applying excessive force (which may damage the plastic pushfit if overtightened).**
12. Screw pushfit (B3) and adaptor (B2) into the filtered cold out flexible hose (B1).
 13. Screw pushfit (C3) and adaptor (C2) into the filtered cold in flexible hose (C1).
 14. Connect the domestic hot water flexible hose (E1) to the hot water isolation valve (G1) using a section of 15mm pipe (G4) and compression nuts (G3) and olives (G2).

15. Arrange and install the domestic cold in isolation valve (G1) and a stub of 15mm pipe (G4) using 15mm compression nut (G3) and olive (G2).
16. Fix the ½" x ½" x ¾" isolating tee valve (G7) to the cold water feed pipe (G4) using 15mm compression nut (G5) and olive (G6). Ensure to arrange the blue lever on the Tee so it is easily accessible for your customer.



If your customer has a water softener installed you must attach the isolating Tee valve (G7) to an unsoftened cold water source, the cold water in flexible hose (F1) can however connect to either a softened or unsoftened water source.

17. Connect the domestic cold in flexible hose (F1) to the ½" x ½" x ¾" isolating tee valve (G7) using 15mm compression nut (G5), olive (G6) and a section of 15mm pipe (F5).
18. Screw the ¾" BSP x ¼" pushfit (C9) onto the three-way valve (G7) ¾" male output.

Install the Filter:

1. Find a suitable place to mount the filter cartridge (C7) under the sink, **it must be mounted vertically**, easily accessible (to be changed periodically), away from any heat source or electrical connections and close enough not to exceed the available length of the ¼" plastic pipe (B4,C4,C8) supplied to reach the between the tap, filter and boiler (place the boiler temporarily to help judge the required lengths of ¼" plastic pipe).
2. Using the self-tapping screw (C6) securely fix the filter bracket (C5) to the cabinet wall.



3. Write the installation date onto the filter label in permanent pen.

4. Clip the filter cartridge (C7) into the bracket (C5) as shown.



You must observe the direction of flow as indicated on the filter cartridge (C7).

5. Measure and then cut required length of ¼" pipe (C4) to connect pushfit (C3) to the filter cartridge (C7) outlet, allow a small amount of extra length to make it easier to change the filter.
6. Firmly push connect the ¼" pipe (C4) between pushfit (C3) and filter cartridge outlet (C7).
7. Measure and then cut required length of ¼" pipe (C8) to connect pushfit (C9) to the filter cartridge (C7) inlet, allow a small amount of extra length to make it easier to change the filter.
8. Firmly push connect the ¼" pipe (C8) between pushfit (C9) and filter cartridge inlet (C7).
9. Firmly push connect the remaining ¼" pipe (B4) into pushfit (B3).

After Installation

1. Ensure that the isolating Tee valve (G7) is in the closed position as shown.
2. Close (turn off) both handles on the tap.
3. Reconnect the domestic hot and cold water supplies and open hot and cold isolation valves (G1). As the system starts to refill, check carefully all new water connections for leaks. After the product installation is complete we recommend you recheck for any slower leaks.

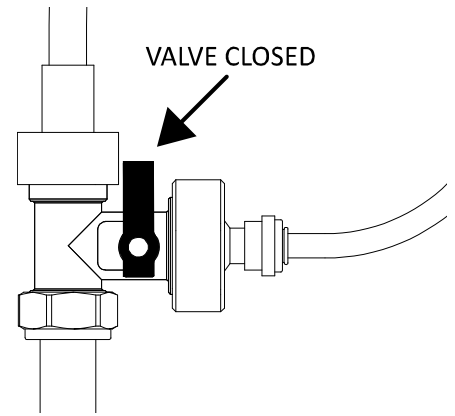

! It is normal for new filter cartridges to lose a small amount of loose carbon when first used and will dissipate with flushing, whilst harmless to consume if the carbon particles are not flushed prior to connection to the boiler they may partly block the boiler and reduce the flow rate. **You must flush the filter for at least 2 litres with cold water or until the water become clear** (without black carbon particles).

4. Ensure that the isolating Tee valve (G7) is in the open position as shown.
5. Place the ¼" pipe (B4) from the tap into a bowl or bucket.
6. Turn on the 98°C forwards handle fully, keep the lever open until all air is expelled and cold (filtered) water exits the ¼" pipe (B4) into the bowl, flush a minimum of a further 2 litres of cold (filtered) water through the ¼" pipe (B4). You may notice a discolouration to the water at first, this is loose carbon particles from the filter it is normal, harmless and will pass with flushing. Continue to flush the filter until the water runs clear. Once complete turn off the 98°C handle.

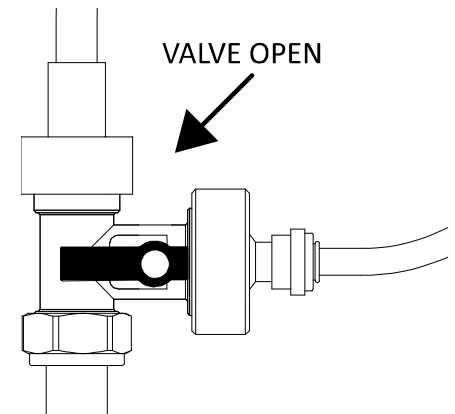

19. You can adjust the flow rate of the filtered water going to both the tap and boiler by adjusting the position of the blue lever on the isolating Tee valve (G7), you should aim for approximately 1-2 litres for both cold filtered and boiled filtered water.
20. Please refer to 'PROBOIL.2X User & Installation Guide' for the next steps on how to install the boiler and connect the tap and filter.

RANGEmaster

Meadow Lane, Long Eaton, Nottingham, NG10 2GD, England

Trade Enquiries: +44 (0)115 946 4000

Consumer Enquiries: +44 (0)1926 457628

E-mail: consumers@agarangemaster.co.uk www.rangemaster.co.uk

Please leave these instructions for your customer

06/2022

PROBOIL.2X

User & Installation Guide

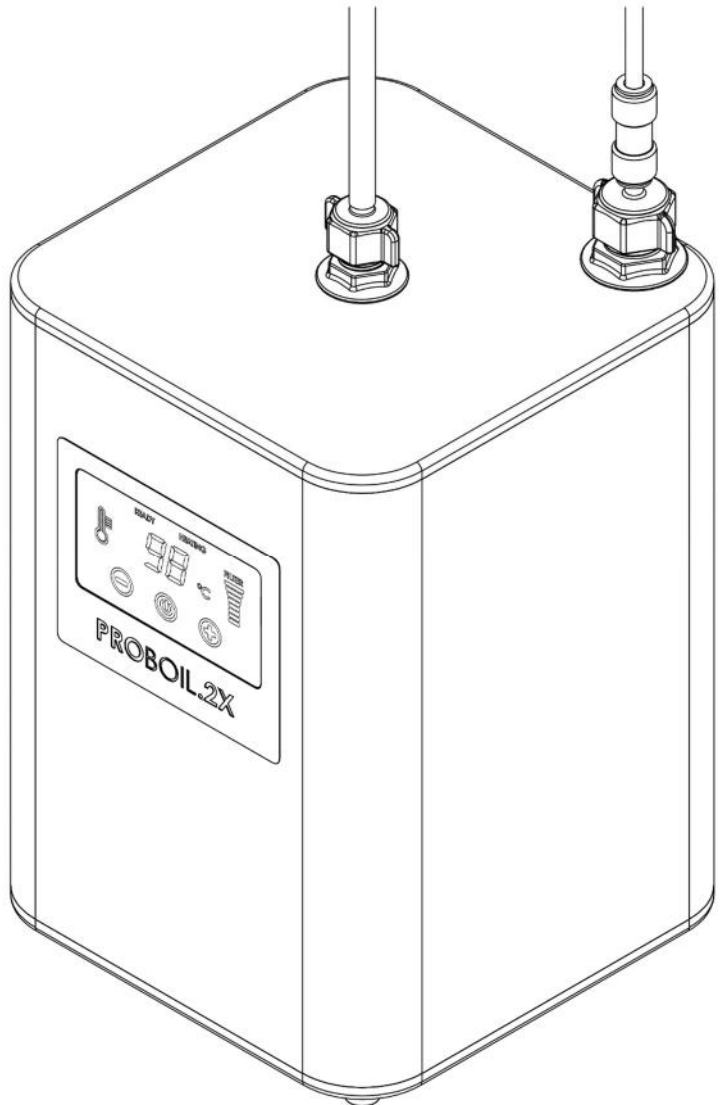

www.proboil.co.uk

See top of boiler unit for contact details

- ① Please read these instructions carefully before installation or use and retain for future reference.
- ① You must install the tap and filter before the boiler.

We have a policy of continued product and quality development and improvement. Accordingly, we reserve the right to amend the specification at any time. All errors and omissions excepted.



1	<u>PROBOIL.2X USER GUIDE</u>	3
1.1	IMPORTANT SAFETY AND USAGE CONSIDERATIONS:	3
1.1.1	GENERAL SAFETY:	3
1.1.2	ELECTRICAL SAFETY:	4
1.1.3	INTENDED PURPOSE:	5
1.1.4	SENSIBLE FIRE SAFETY PRECAUTIONS:	5
1.1.5	DAY TO DAY USAGE CONSIDERATIONS:	6
	<i>Using the product safely</i>	6
	<i>To dispense hot water (Model may vary):</i>	7
	<i>⚠ Reducing the risk of splashing:</i>	7
	<i>To get the best results:</i>	7
	<i>Periods of non-use</i>	7
	<i>Aesthetic cleaning</i>	8
1.2	USING THE PRODUCT:	9
1.2.1	BOILER SCREEN AND INTERFACE:	9
1.2.2	FILTER REPLACEMENT GUIDE:	11
1.2.3	DESCALING THE PROBOIL SYSTEM:.....	16
	<i>The aerator on the end of the tap/dispenser spout:</i>	16
	<i>The water tank within the PROBOIL.2X boiler:</i>	17
1.2.4	CLEANING AND STERILISING THE PROBOIL SYSTEM INTERNAL TANK:	20
1.3	TROUBLESHOOTING:	23
1.3.1	BOILER SCREEN AND INTERFACE:	23
1.3.2	WATER TEMPERATURE:	23
1.3.3	WATER DRIPPING FROM THE SPOUT END WHEN THE HANDLE IS IN THE OFF POSITION:	24
1.3.4	WATER FLOW RATE / STREAM QUALITY:	24
1.3.5	LEAKING FROM THE BOILER.....	25
1.4	WARRANTY TERMS AND CONDITIONS:	26
2	<u>PROBOIL.2X INSTALLER GUIDE</u>	27
2.1	ABOUT THE PROBOIL.2X WATER HEATER:	27
2.1.1	IMPORTANT TECHNICAL DATA:	27
	<i>Boiler:</i>	27
	<i>Filter cartridge:</i>	28
	<i>Tap / dispenser:</i>	28
2.1.2	PARTS AND CONTENTS:	29
2.2	INSTALLATION:	30
2.2.1	INSTALLATION PREPARATION.....	30
	<i>About the product:</i>	31
	<i>Install location:</i>	31
	<i>Electrical:</i>	31
	<i>Plumbing:</i>	31
2.2.2	INSTALL THE TAP.....	32
2.2.3	INSTALL THE FILTER	33
2.2.4	INSTALL THE BOILER	34
2.2.5	COMMISSIONING AND TESTING	38
	<i>Commissioning checklist:</i>	38

Thank you for choosing PROBOIL.2X. By reading this entire guide you will ensure that the product is installed and used safely and will give its best performance, this guide should be used in conjunction with any additional product guides.

1 PROBOIL.2X user guide

1.1 Important safety and usage considerations:

Throughout this guide, the following symbols are used to highlight key points or safety considerations.

 An information point or tip for installation or usage.	 A service, maintenance or care consideration.	 A technical or safety consideration or warning of hazardous situation with regard to life and property.
--	---	---

1.1.1 General safety:

 **WARNING:** This appliance can be used by children aged from 8 years and above and persons with reduced physical, sensory or mental capabilities or lack of experience and knowledge only if they have been given supervision or instruction concerning use of the appliance in a safe way and have understood the hazards involved. Children should not be allowed to play with the appliance. Cleaning and user maintenance should not be made by children unless they are older than 8 and supervised.

 **WARNING:** Servicing and maintenance of this product must be carried out by authorised persons having knowledge and practical experience of the appliance, in particular as far as safety and hygiene are concerned. The PROBOIL system contains no user serviceable parts and should only ever be serviced by the recommended service agent. In the event of any suspected problem you should immediately cease usage, isolate the water supply, disconnect the power and contact the service agent noted on the top of the boiler.

 **WARNING:** This product should only be installed into an internal domestic environment with an ambient temperature of 10-40°C. If the unit is accidentally left filled in an unheated environment for a prolonged period, do not switch it on if there is a possibility that the water inside is frozen, it must defrost naturally.

 **WARNING:** All surfaces, especially those made from metal, may become hot whilst in operation. Use caution when touching these surfaces. Inform all users that the surfaces may become hot.

 **WARNING:** Never use this appliance when your judgement or coordination may be impaired by the use of either alcohol or drugs.

 **WARNING:** Do not open or disconnect the tank until the tank has cooled to a safe temperature.

 **WARNING:** If the appliance is to be handed over to someone else for use, all documentation and information should also be given.

 **WARNING:** This appliance must be installed respecting local plumbing and electrical regulations.

 **WARNING:** This appliance must use only genuine parts and accessories and sundry consumables.

 **WARNING:** Packaging materials can be dangerous to children and animals; ensure they are disposed of safely and correctly according to local laws.

1.1.2 Electrical safety:

 **WARNING:** Do not use this appliance if you suspect it or any of its cables or hoses are damaged or kinked in any way, or is performing differently from how you would expect. Never use any appliance with a damaged mains power lead. In the event of any suspected problem you should immediately cease usage, isolate the water supply, disconnect the power and contact the service agent noted on the top of the boiler.

 **WARNING:** This appliance must be disconnected from the power during installation, maintenance or cleaning.

 **WARNING:** Only use the supplied power cable and connect it directly to the power outlet rather than an extension power outlet.

 **WARNING:** The appliance must be installed so that it can be disconnected from the mains power supply and the outlet socket must be accessible at all time.

 **WARNING:** This appliance must be connected to a grounded / earthed power outlet only.

 **WARNING:** This appliance must be installed respecting local plumbing and electrical regulations.

 **WARNING:** Do not place any water connections directly near or above electrical appliances or connections.

 **WARNING:** This appliance is not intended to be operated by means of an external timer or separate remote control system.

 **WARNING:** unless attached to a modern consumer unit with RCD protection we recommend installing a local RCD protection device in the socket being used by the appliance.

1.1.3 Intended purpose:

 **WARNING:** This appliance must only be used for heating water.

 This appliance is intended only for domestic use and should not be used for commercial purposes.

 Do not add to, exchange or modify any component of the boiler, mixer tap, filter or connections from those supplied and install them only as instructed. The spout exit or any part of the system must not include any additional third party adaptors or connections that will add resistance to the system.

 We only warrant the original filter type supplied with your boiler which is formulated specifically for the PROBOIL product. If the filter is removed or exchanged for an alternative model it may have a detrimental effect to your system and accordingly will invalidate your warranty. If you have specific or unusual incoming water conditions, please contact the service number on the boiler for further advice.

 This appliance is intended to be permanently connected to the water mains.

 The boiler and mixer tap are not designed to work with any other combination of appliances other than as shown within this guide.

1.1.4 Sensible fire safety precautions:

 Do not store or use petrol or other flammable rags, paper, aerosols, vapours or liquids in the vicinity of this or any other appliance.

 Install the unit on a heat-resistant surface. Make sure that the installation surface is firm and level.

 For safety regulations the plug or means of disconnection must always be accessible after installation.

 Do not use any water jet or steam near this appliance.

 Always ensure an airgap of at least 10mm around the appliance and that any closed cabinet has sufficient airflow.

1.1.5 Day to day usage considerations:

Using the product safely

 Hot water: We have taken great care to deliver a product with many built in safety features, but you will also need to take due care when dispensing heated water to avoid accidental scalding. It is important that everyone who uses this product understands how to use it safely. The example shown in this guide may vary slightly from model to model.

 Continual short dispenses of water <100ml may fill the internal expansion vessel in the boiler, this may cause the product to drip water from the tap spout when the boiler is heating, if you experience this then dispense a few litres of water to self-empty the expansion vessel.

To dispense hot water (Model may vary):

- 1) Fully push the 98° water lever down to bypass the child lock and simultaneously turn the handle forwards, the further the lever is turned the greater the flow.
- 2) At around 45° rotation is reached (Fig 2.) and the maximum flow is achieved. It is normal for the hot water to take a moment to dispense as the water may empty from the product after use.
- 3) After use ensure to close the 98° water handle, when fully closed the child lock will self-engage. Certain models may also include a self-closing handle. It is normal for the hot water to take a moment to stop fully as the pressure in the system drops and remaining water in the tap drains.

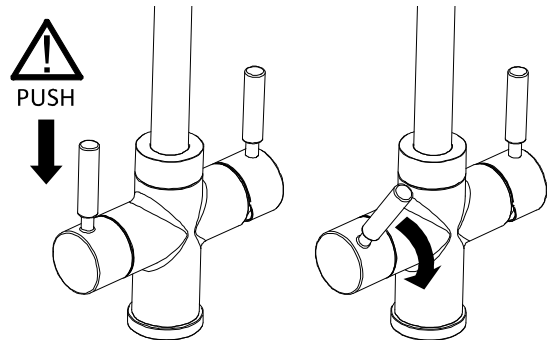

NOTE: PLEASE REFER TO THE TAP INSTALLATION GUIDE FOR YOUR CHOSEN TAP AS MODELS VARY

Reducing the risk of splashing:

- 1) Avoid holding the vessel that you are filling too far away or close from the spout exit. We recommend around 5-10cm (2-4").
- 2) Tilt the cup slightly to reduce the splashing from the base of the cup.
- 3) Turn the 98° water handle on slowly and progressively once the cup is part full then open the handle more.

Eliminate backflow contamination:

As your mixer tap has multiple waterways, as with all taps it is important to eliminate the risk of back flow contamination in waterways.

- 1) Always respect the minimum gap between the spout exit and the vessel being filled.
- 2) Never use 98° water at the same time as any other water source.

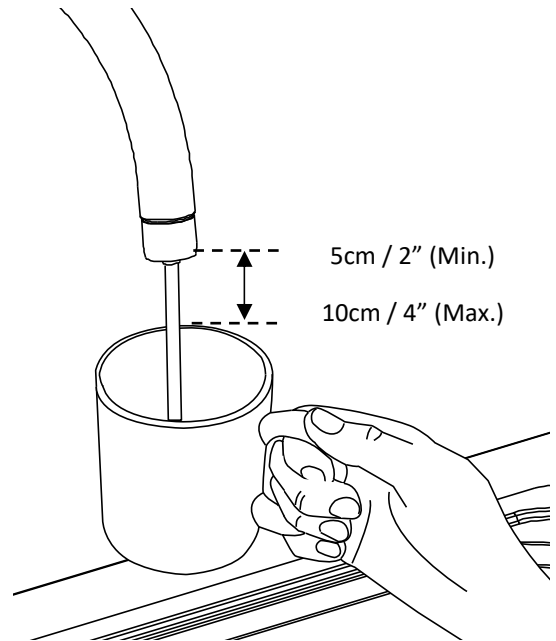

To get the best results:

 Each time the product is used you should flush a small amount of boiled water through before use. This ensures fresh water is dispensed, typically this can be used to preheat your cup. If unused for extended periods, then flush the product for a longer time.

Periods of non-use

 If the product is going to remain unused and unattended for example you are away for a few days, we recommend changing the temperature to its minimum setting 75°C, this will reduce the energy consumption and encourage sanitary conditions.

 **WARNING:** If you are not using the product and leaving it unattended for a period longer than 1 week you should turn the boiler into standby mode (see using the product section), do not turn off the power at the mains socket as this will reset the filter counter.

You may also consider closing your mains stop cock to prevent flood damage from any of the water using appliances in your household.

Upon returning after an extended period of absence with the heating power off you must re-sanitise the boiler and connections by following the steps below.

1. Turn on both the water supply (if previously isolated) and the boiler
2. Adjust the boiler temperature to 98°C
3. Wait for the boiler to display “READY”
4. Wait a further 10 minutes
5. Dispense the entire contents of the boiler as normal until the heated water stream is entirely cold then allow it to continue to run for 5 minutes.
6. Turn on the standard cold tap and run this for 5 minutes also at the same time
7. Turn off the heated water and cold water taps
8. Allow the boiler to reheat fully to 98°C and display “ready” before use

Aesthetic cleaning

 Use of any cleaners with acids, abrasives, alkaline or organic solvents, on any part of the product can result in deterioration of the components and will void the warranty. Clean the product only with a mild dish soap and a damp non-abrasive cloth.

 **WARNING:** Do not use any excess water or steam jet when cleaning this appliance.

 **WARNING:** Cleaning and user maintenance shall not be performed by children without supervision.

 **WARNING:** Disconnect the appliance from the power outlet before cleaning, allow the product to cool before cleaning and take care of any surfaces or components that may still be hot.

 You should ensure the boiler is and tap aerator are both free of limescale to ensure continuous safe and energy efficient usage of this product. Advice on sterilisation and descaling are covered separately within this guide.

1.2 Using the product:

1.2.1 Boiler screen and interface:

The boiler uses a touch screen interface to both display and change the status of the boiler.

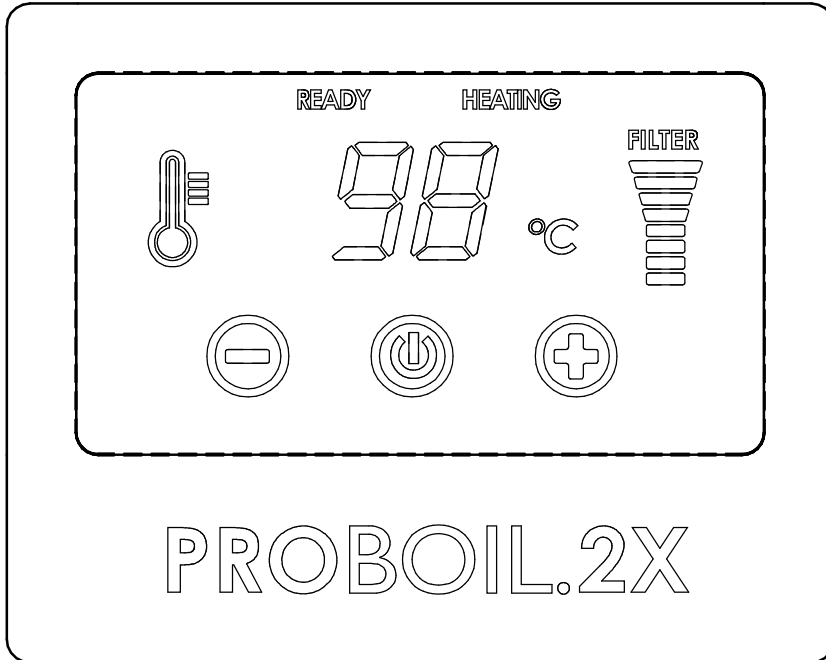

Temperature adjust:

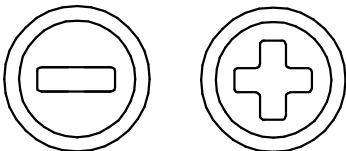

Touch sensitive **-** & **+** keys lower and raise the boilers maximum target temperature between a selection of pre-set values 75, 85, 90, 95, 96, 97- 98°C

White colour, constantly illuminated when unit is not in standby mode, the boiler will beep when pressed to acknowledge the command.

The water inside the boiler tank will not exceed 98° to ensure compliance to local safety laws.

Standby:

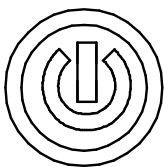

Touch sensitive **⏻** key switches the unit between on and standby modes, press and hold for 1.5 seconds to activate.

When in standby mode the water inside the boiler will not be heated.

Touch sensitive, white colour, constantly illuminated when unit is not in standby mode, flashes when in standby mode.

The boiler will beep when pressed to acknowledge the command.

Ready indicator:

READY

Displays when the boiler is not in a heating phase indicating the water is at or near the pre-set target temperature.

Blue colour, constant illumination when unit not in standby mode or the boiler is heating.

HEATING

Heating indicator:

Displays when the boiler is in a heating stage indicating the boiler is re-heating the water inside to achieve the pre-set target temperature.

It is normal for the heating indicator to switch off before the target temperature is achieved as remaining heat inside the unit is still to disperse fully into the stored water.

Red colour, constantly illuminated when heating element is on (unless in standby mode).

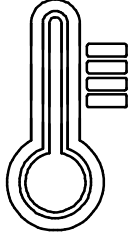

Thermometer symbol:

Red colour, constantly illuminated when the unit is not in standby mode.

Filter life indicator bars:

Displays the used and remaining time until the filter cartridge must be replaced.

On initial power on or after the counter is reset it will display the following bars 1 x red, 1 x orange, 6 x blue

As time passes blue and orange bars will disappear indicating the expired time.

When all the bottom bar is flashing red you must replace the filter cartridge regardless of the amount of usage both to protect the internal components of the boiler and ensure hygiene. Each filter has a usable life of 6 months.

If the filter life is exceeded the product will beep daily to serve as an audible reminder.

We also operate a free reminder service when you register online.

In the event that power is interrupted to the boiler the filter counter will be reset accordingly we also recommend you write the installation date on the filter label.

Pressing and simultaneously holding both **-** & **+** buttons for apx. 1 Second will reset the filter life timer.

The 2 digit “multifunction” display:

Displays various information depending on the status of the boiler and the last key press:

- 1) **Current in tank water temperature:** in normal use (without prior key press) the current approximate water temperature in the tank will be displayed. To reduce energy use it is normal for the displayed temperature to reduce by a few degrees before being reheated back to the target temperature.
- 2) **Target in tank water temperature:** After either the **+** or **-** key is pressed on the display the multifunction display will change to show the desired target temperature, after a moment it will then revert to displaying the current temperature:
- 3) **Troubleshooting error codes:** In the event of the boiler self-diagnosing a problem it will display an “E” code to help to diagnose the fault, see troubleshooting section.

Blue colour, constantly illuminated when the unit is not in standby mode.

FILTER

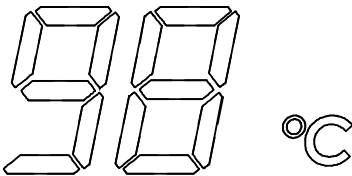
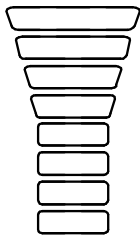

1.2.2 Filter replacement guide:

The product is supplied with a filter specifically designed to both improve the taste and clarity of the water but also to assist protecting the boiler from contaminants and scale.

 Each filter has a maximum life span of 6 months or 1000 litres (apx. 2800 cups), whichever occurs first. Regardless of the amount of usage it is required for you to replace the filter on schedule for reasons of product protections, hygiene and maintaining your warranty. The recommended replacement frequency may increase in hard water areas or high usage applications.

Only genuine parts must be used to maintain your product warranty, these are available at proboil.co.uk or by calling (+44) 01226 283434.

Before beginning you should have ready to hand:

- Your replacement filter
- A large bowl or pan or jug or small bucket.
- A cloth
- A permanent pen

1. Remove the new filter from its packaging and remove any end dust caps (plugs) from both ends of the filter.



2. Write today's date on the "installed on" section on the filter's label in permanent pen.

****Recommended / Maximum replacement interval: 6/12 months.**

Installed on:

3. **Only If your tap includes a cold filtered water dispense option:**

- a. Ensure to turn off the valve directly before the filter inlet so the valve is in the indicated "closed" position.
- b. Turn the tap handle to dispense filtered cold water, let it run until the water slows then stops completely then turn the filtered water handle to the off position.

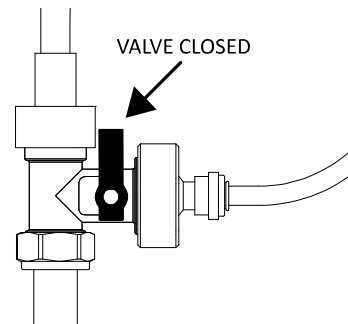

4. **If your tap does not include a cold filtered water dispense option:** Turn the 98° handle to the off (upright) position.

5. Pull the existing filter cartridge from its wall mounting clip, with the blue tubes still connected.

6. Place a bowl (or similar) under the filter cartridge and pipes to catch any retained water in the system.

7. Take note of the direction (orientation) of the filter installed. The "FLOW->" indication on the label shows the direction of water flow from inlet to outlet. It is important that the blue flexible pipes are reinserted back into the same inlet and outlet sides of the new filter cartridge. You might wish to mark the blue pipe on the "inlet" side of the filter with the permanent pen as memory aid for later.

8. Remove the blue flexible pipe from both ends of the filter cartridge.

To do this you should push the collet (see drawing) towards the centre of the filter whilst simultaneously pulling the blue flexible pipe in the opposite direction away from the filter.

As the pipes are removed it is normal for a small amount of water in the pipes and filter to be released, catch this with the bowl and or cloth.

9. Check both ends of the blue flexible pipe for any signs of wear, if the ends of the pipe are badly worn you must cut away the damaged section cleanly and squarely using a snip tool, sharp craft blade or similar.

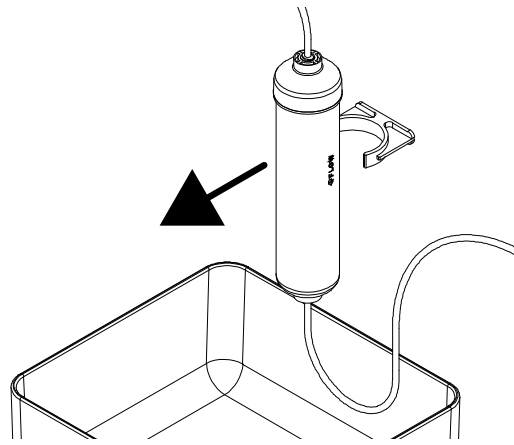

IMPORTANT
When installing this filter, you must flush 2 litres of water to an external drain **BEFORE** connecting the filter outlet pipe to the appliance or tap. Afterwards, flush according to the instructions supplied.



- Min / Max pressure: 0.5 / 5.5 Bar
- Rated Capacity: 1000 L*
- Min / Max water temp 1° - 23°
- *Hardness only capacity at a temporary hardness of 150ppm and a flow rate of 2L/Min.

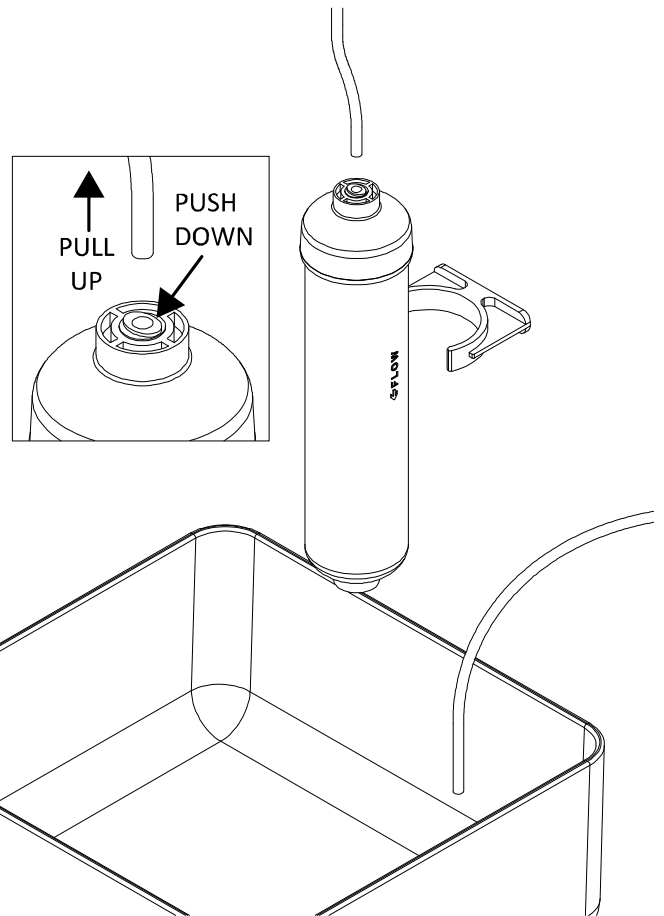

10. Push the “inlet” flexible blue pipe **firmly and fully** into the new filter cartridge inlet.

Hold the filter and pull the pipe away from the filter to check it has inserted correctly. If the fit is too tight to push home the pipe fully add a single drop of dish soap onto the end of the pipe and push firmly.

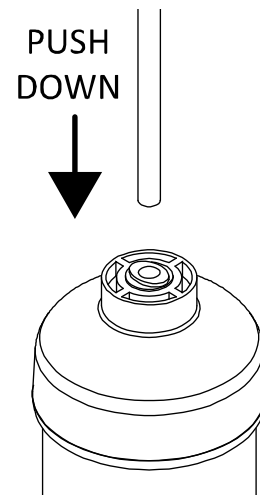

11. It is normal for new filters to lose a small amount of loose carbon when first used and will dissipate with flushing, whilst harmless to consume if the carbon particles are not flushed prior to connection to the boiler they may partly block the boiler and reduce the flow rate. You must flush the filter for at least 2 litres with cold water or until the water become clear (without black carbon particles).

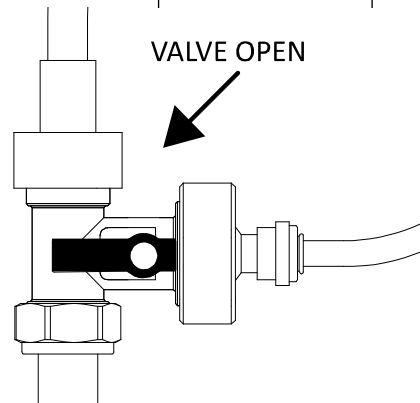

(fig1.)

12. Flushing the filter (**Only If your tap DOES include a cold filtered water dispense option**):

- a. Place the outlet of the filter cartridge over the bowl.
- b. Turn the Tee valve partly and slowly to the “on/open” position (fig. 1).
- c. Once the Tee valve is “open” air within the filter will purge (spitting is normal at first) and the water will start to flow from the filter exit.
- d. Run the water into the bowl until it runs clear of loose carbon.
- e. Turn the Tee valve fully to the “off/closed” position (fig. 2).

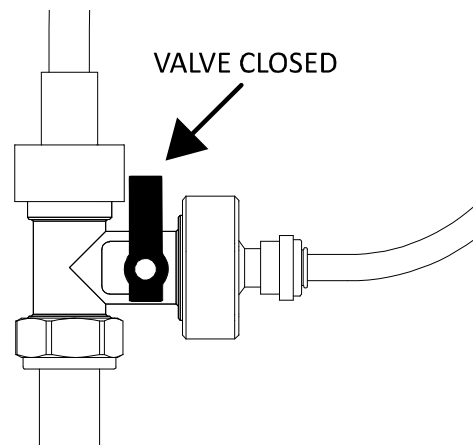

(fig2.)

13. Flushing the filter (**Only If your tap DOES NOT include a cold filtered water dispense option**):

- a. Place the outlet of the filter cartridge over the bowl.
- b. Turn the 98° tap handle to the “on/open” position.
- c. Once the handle is “on/open” air within the filter will purge (spitting is normal at first) and the water will start to flow from the filter exit.
- d. Run the water into the bowl until it runs clear of loose carbon.
- e. Turn the 98° tap handle fully to the “off/closed” (vertical) position.

14. Push the “outlet” flexible blue pipe **firmly and fully** into the new filter cartridge outlet.

Hold the filter and pull the pipe away from the filter to check it has inserted correctly. If the fit is too tight to push home the pipe fully add a single drop of dish soap onto the end of the pipe and push firmly.

15. Push the new filter cartridge into its wall mounting clip, ensure to leave the label visible.

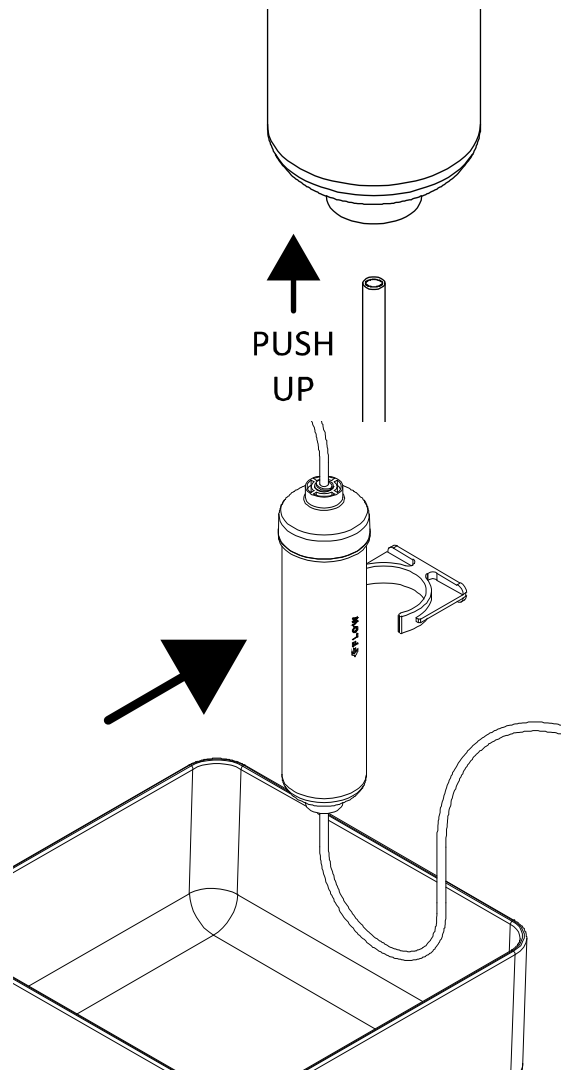

16. Reconnect the water to the filter (**Only if your tap DOES include a cold filtered water dispense option**):

- Turn the tap handle for filtered cold water fully turned on.
- Turn the Tee valve (fig.3) to the on position, adjust the exact TEE valve position needed to adjust the flow of filtered water to around 2 litres per minute. This can be checked with a timer and kitchen measuring jug.
- Once adjusted turn off the cold filtered water tap handle.

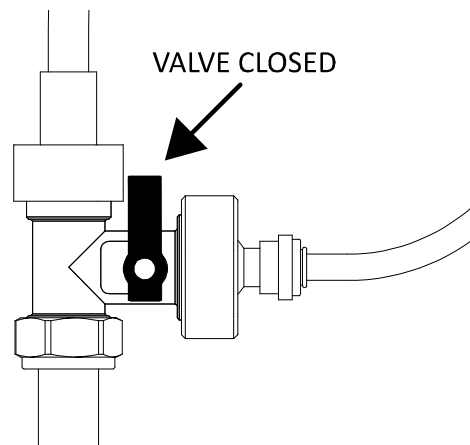

(Fig 3.)

17. Turn the 98°C water handle fully on, note: initially as the air purges you may get some spitting from the end of the tap, this is normal, leave the 98°C handle in the “on/open” position and flush a for a further 5 minutes or 5 litres.

18. Wait for the boiler to show “READY” before use.

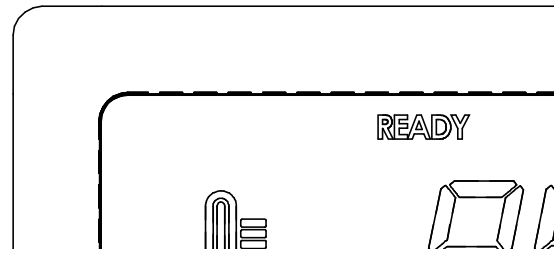

19. If the used filter cartridge is applicable for our recycling scheme please leave it upwards in the sink to drain any residual water from inside before packing and returning it as instructed.

1.2.3 Descaling the PROBOIL system:

 PROBOIL2X like all other appliances that use hot water can become coated with limescale over time, replacing your filter frequently will help delay this. Depending on the frequency of your usage pattern and the harder the water in your area, the quicker you should expect the limescale to build and therefore will need to be cleaned and descaled.

Only genuine parts must be used to maintain your product warranty, these are available at proboil.co.uk or by calling (+44) 01226 283434.

There are two key parts of the product that likely will need descaling:

The aerator on the end of the tap/dispenser spout:

If the aerator at the end of the tap spout contains debris or scale then it will reduce the flow rate of the water and may cause more splashing when in use.

The aerator and its housing can be descaled using ordinary white wine vinegar and water solution.

- 1) Press and hold the  key for 1.5 seconds to activate, this will turn the boiler into “standby” mode.
- 2) Unscrew and remove the aerator housing **(1)** anti clockwise (use rubber gloves if you need to get a better grip).
- 3) Whilst holding the spout centre tube **(4)** pull the aerator **(2)** away from the spout.

The method may vary depending on the model installed.

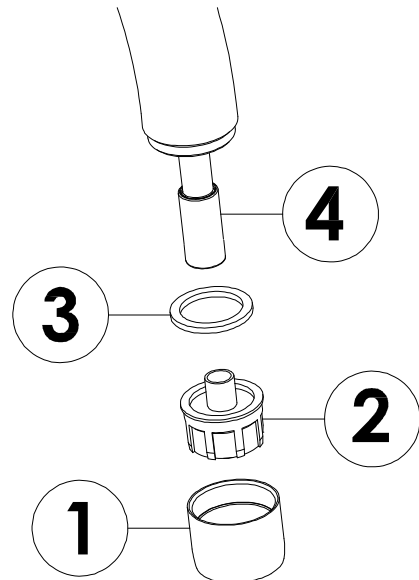

- 4) Place the aerator **(2)** and if required the aerator housing **(1)** into a small cup sufficiently filled with white wine vinegar and water.
- 5) Leave the parts soaking for around 5 minutes
- 6) Clean the scale from the parts using a non-abrasive tool such as a toothbrush. If the scale is not cleared repeat step (5).
- 7) Once clean of scale and debris rinse the parts thoroughly in cold water.
- 8) Reassemble the parts in the reverse order, you must ensure the aerator **(2)** is firmly pushed into the spouts centre tube **(4)**. Also make sure seal **(3)** is in place.
- 9) Press and hold the  key for 1.5 seconds to activate, this will turn the boiler back on from “standby” mode.

The water tank within the PROBOIL.2X boiler:

The filter system provided with PROBOIL will help to prevent of the calcification (scaling) of the boiler. However it will be required from time to time that the PROBOIL will need to be descaled, drained and refilled to ensure the maximum energy efficiency and service life from the product especially in hard water areas. The frequency of descaling will depend entirely on your water hardness, the suggested minimum descaling frequency is once annually. Descaling solutions can be obtained by contacting proboil.co.uk or by calling (+44) 01226 283434.

If the tank within the boiler becomes calcified it will lead to a reduction of both energy efficiency and temperature accuracy of the boiler. The boiler must only be cleaned using only genuine PROBOIL descaling solution to maintain your product warranty, other formulations may cause inadvertent damage.

⚠ WARNING: Harmful if swallowed. Irritating to eyes and skin. **KEEP OUT OF REACH OF CHILDREN.** Avoid contact with skin and eyes. In case of contact with eyes, rinse immediately with plenty of water and seek medical advice. After contact with skin, wash immediately with plenty of water. If swallowed, seek medical advice immediately and show this container or label.

Descaler Ingredients: Sulfamic Acid. Country of origin USA. See www.proboil.co.uk for further information and SDS.

⚠ The descaling chemical is acidic and should only be used and handled as indicated, care should be taken not to ingest, expose to skin, clothing or decorative surfaces. Take care when touching all surfaces and when disconnecting or connecting hoses they may be hot and or generate steam, you must use personal protective wear to prevent accidental scalding.

i During the descaling process you will need to disconnect the boiler power, this will reset the filter life counter. If your boiler is calcified it is likely the filter cartridge is overdue replacement, if this is the case you should change the filter after descaling the boiler.

- 1) Press and hold the **⏻** key for 1.5 seconds to activate, this will turn the boiler into standby mode
- 2) Turn the 98°C tap handle on fully, run for at least 3 litres or until the stream of water runs fully cold.
- 3) Pull the mains power plug out from the socket on the left-hand face of the boiler
- 4) Unscrew and detach the blue inlet wing nut connector (**G**) from the top of the boiler (**B**).

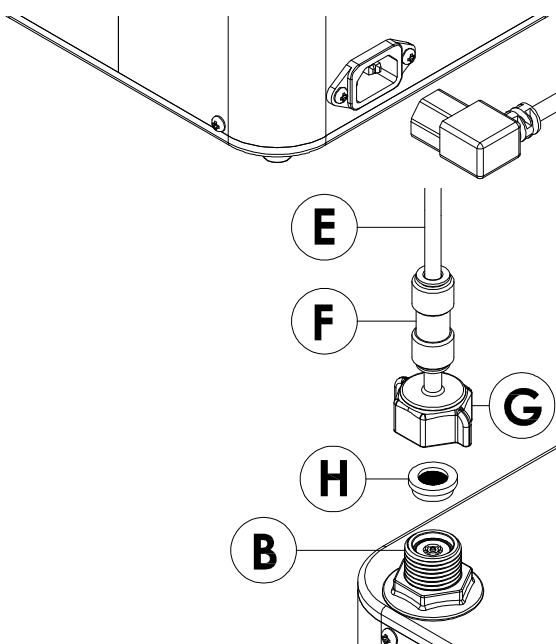

- 5) Firmly pull the silicone rubber high temperature output hose (**K**) off from the red outlet wing nut (**J**) connector.
- 6) Lift up then pull the boiler to unhook the boiler from its keyhole slots away from the wall it is mounted on.
- 7) Unscrew and detach the red outlet wing nut (**J**) connector from the top of the boiler (**C**).
- 8) If the 3/8" rubber seal (**I**) becomes detached from the red outlet wing nut (**J**) connector then reinsert it the seal inside connector (**J**).

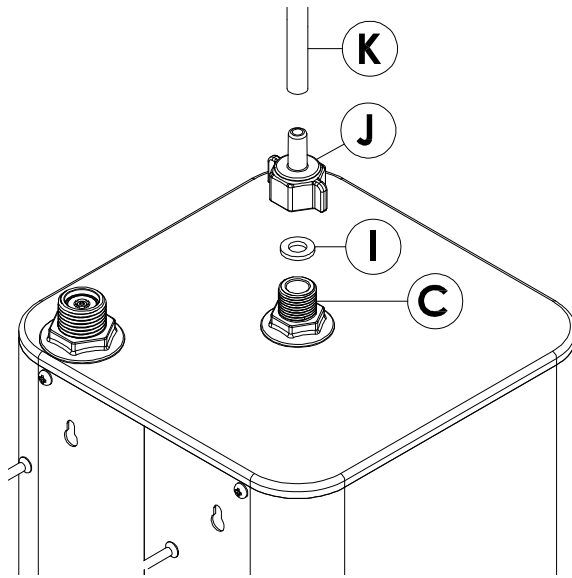

- 9) Remove the inlet meshed filter seal (**H**) from the boiler inlet (**B**) or inlet adaptor (**G**), rinse the washer in cold water, and use a toothbrush to clean any debris from it. If meshed seal (**H**) is compressed inside inlet (**B**) or adaptor (**G**) then use a cocktail stick (or similar) to remove it.

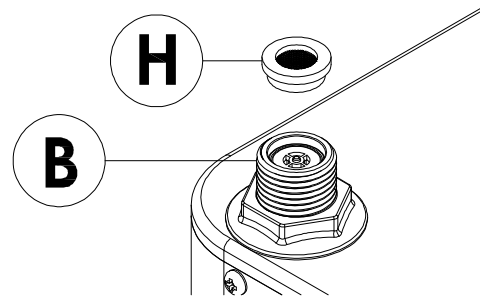

9. Whilst taking care lift the PROBOIL.2X (**A**) unit out from the cabinet and place it on the countertop.

10. Each bottle of PROBOIL descaling solution contains 200ml of descaling solution, one bottle should be enough to descale the tank, however if you believe the tank to be heavily scaled then use both the 200ml bottles supplied.

i You can empty the boiler faster from the outlet (**C**) by depressing the centre of the check valve insert found in the boiler inlet (**B**) whilst the boiler is upside down.

11. Tip the boiler upside down so the boiler's centre outlet (**C**) is over the sink, you must empty the boiler as much as possible of water and any debris, tip the boiler back and forth to hear how much water remains inside if you are unsure.

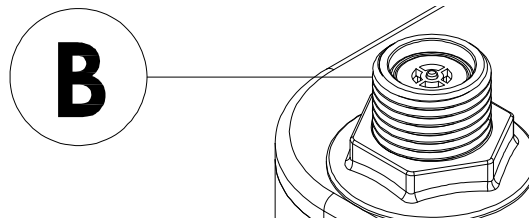

12. Shake the descaler bottle(s) thoroughly.

13. Cut the top from the bottle nozzle(s) using sharp scissors.

14. Carefully squeeze the entire contents of the bottle(s) into the outlet (**C**) of the tank.

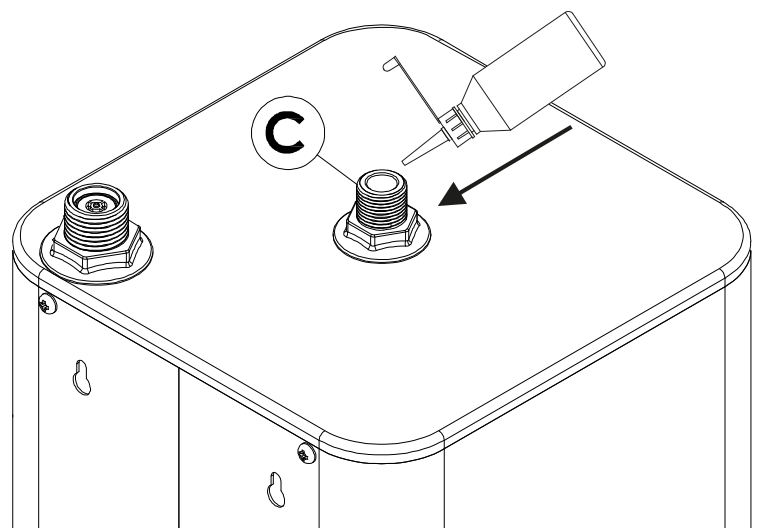

15. Reconnect all the removed parts from the boiler in the reverse order listed above. **(do not use a spanner or overtighten connectors G or J)**

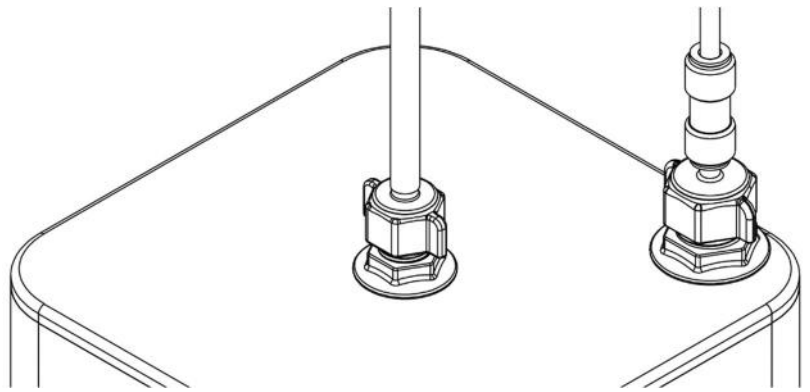

16. Turn on the 98°C tap handle on slowly, keep the handle on until you see water exit the spout of the tap then turn it off immediately.
17. Press and hold the **⏻** key for 1.5 seconds to activate, this will turn the boiler back on from “standby” mode.
18. Use the **+** and **-** key to change the target temperature on screen.
Change the pre-set water target temperature to 85°C
19. Wait for the PROBOIL.2X unit to display “READY” onscreen

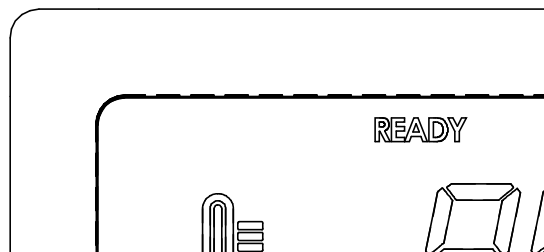

20. **Take note of the time and wait for no longer than a further 30 minutes maximum** for the descaler liquid to work. It is normal for an odour to be present during this time.
21. **Remove the aerator from the end of the spout** (see previous section for details).

i Note if the aerator is not removed you can expect to block the aerator with partially dissolved scale, this must be avoided.

Turn the 98°C tap handle on fully, **allow to run for at least 20 litres** (use a kitchen measuring jug) or until the water stream runs clear.

22. If dirt, debris or scale remain inside the tank then you can repeat the process steps 1-21 (as above) again if needed.
23. Once completed reassemble the spout aerator **(2)** in the reverse order, you must ensure the aerator **(2)** is firmly pushed into the spouts centre tube **(4)**.
24. Should any residual taste from the descaler remain flush additional water through the boiler until it subsides.

1.2.4 Cleaning and sterilising the PROBOIL system internal tank:

 Periodically it is prudent to clean the PROBOIL.2X boiler this might be because the boiler has been left switched off for long periods, possible contamination from dirt or debris, unwanted taste. When you clean the boiler we recommend you follow the descaling procedure first.

- 1) Press and hold the  key for 1.5 seconds to activate, this will turn the boiler into standby mode.
- 2) Turn the 98°C tap handle on fully, run for at least 3 litres or until the stream runs fully cold.
- 3) Pull the mains power plug out from the socket on the left-hand face of the boiler

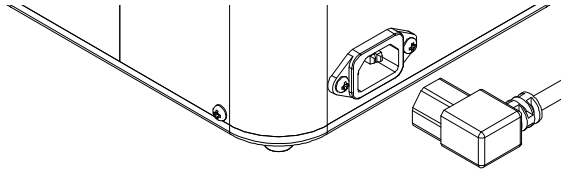

- 4) Unscrew and detach the blue inlet wing nut connector (**G**) from the top of the boiler (**B**).

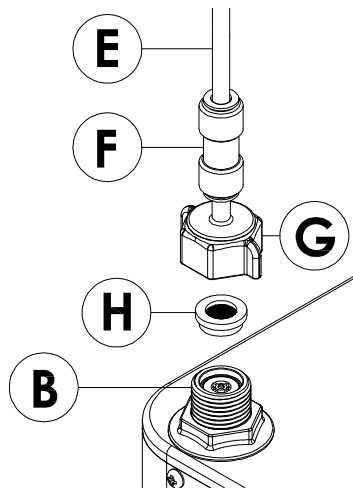

- 5) Firmly pull the silicone rubber high temperature output hose off from the red outlet wing nut (**K**) connector.
- 6) Lift up then pull the boiler to unhook the boiler from its keyhole slots away from the wall it is mounted on.
- 7) Unscrew and detach the red outlet wing nut (**J**) connector from the top of the boiler (**C**).
- 8) If the 3/8" rubber seal (**I**) becomes detached from the red outlet wing nut (**J**) connector then reinsert it the seal inside connector (**J**).

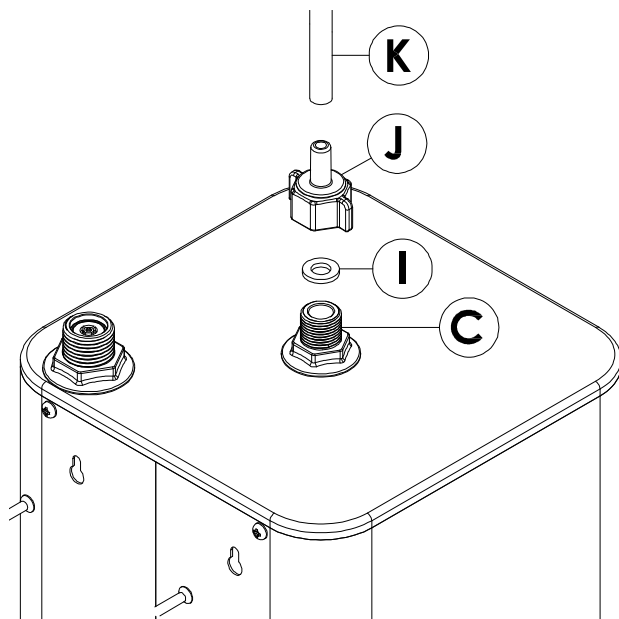

- 9) Remove the inlet meshed filter seal (**H**) from the boiler inlet (**B**) or inlet adaptor (**G**), rinse the washer in cold water, and use a toothbrush to clean any debris from it. If meshed seal (**H**) is compressed inside inlet (**B**) or adaptor (**G**) then use a cocktail stick (or similar) to remove it.

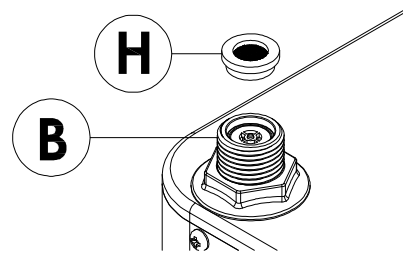

9. Whilst taking care lift the PROBOIL.2X (**A**) unit out from the base unit and place it on the countertop.

10. Tip the boiler upside down so the boiler centre outlet (**C**) is over the sink, you must empty the boiler as much as possible of water and any debris, tip the boiler back and forth to hear how much water remains inside if you are unsure.

i You can empty the boiler faster from the outlet (**C**) by depressing the centre of the check valve insert found in the boiler inlet (**B**) whilst the boiler is upside down.

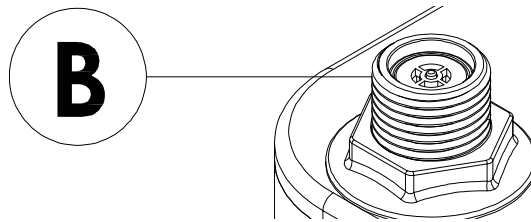

11. Use only a non-aggressive infant sterilising solution (for example “Milton” concentrate). Always read the label regarding the dilution

i **The total Proboil tank volume is 2.1 litres** so for a 0.6% v/v Milton concentrate liquid we suggest you require a maximum of 13ml of concentrate.

Carefully measure out the sterilising solution then tip the required amount of the solution into the centre boiler outlet.

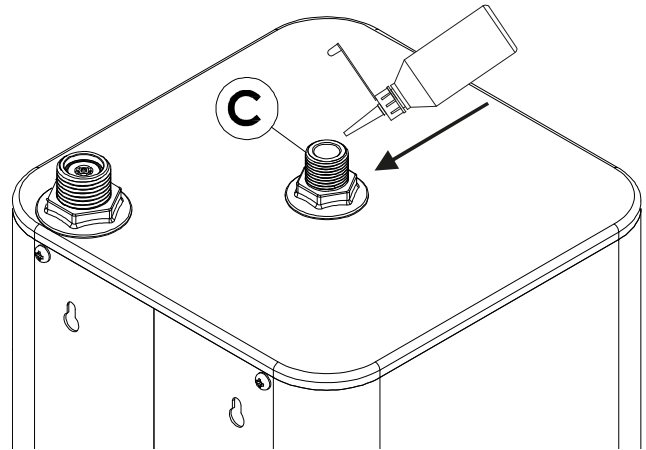

12. Reconnect all the removed parts from the boiler in the reverse order listed above. **(do not use a spanner or overtighten connectors G or J)**

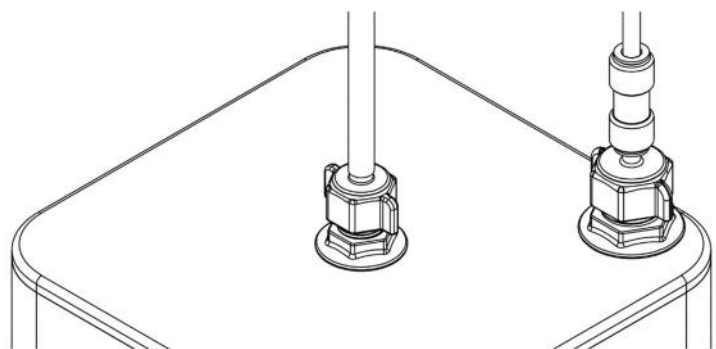

13. Turn on the 98°C tap handle on slowly, keep the handle on until you see water exit the spout of the tap then turn it off immediately.

14. Press and hold the **⏻** key for 1.5 seconds to activate, this will turn the boiler back on from “standby” mode

15. Use the **+** and **-** key to change the target temperature on screen.
Change the pre-set water **target temperature to 98°C**

16. Wait for the PROBOIL.2X unit to display "READY" onscreen

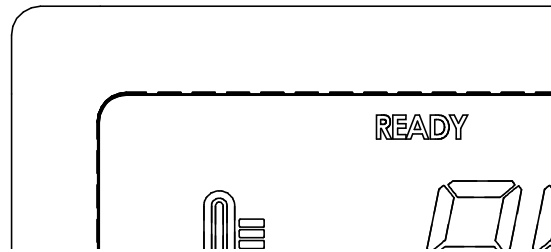

17. Take note of the time and wait for **no longer than a further 10 minutes maximum** for the sterilising liquid to work. It is normal for an odour to be present during this time.

18. Turn the boiler back into standby mode

19. Turn on the 98°C tap handle on fully, keep the handle on for a minimum of 5 minutes.

20. Turn the boiler back on and set it to the desired target temperature, wait until the display shows "READY".

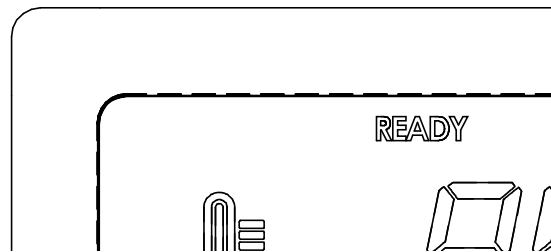



21. If dirt, debris or taste remains then you can flush the tap for a further 5 minutes or repeat the process steps 1-20 again if needed.

1.3 Troubleshooting:

 If you suspect your product has a fault you can use the guide below or if you are unsure about your issue you should isolate both the mains power and water and contact the service number on top of the boiler.

1.3.1 Boiler screen and interface:

Issue description:	Possible issue & solutions:
no display illuminated (only displaying )	Unit is in standby mode: press and hold  for 1.5 seconds to revert to normal mode.
no display illuminated (including no )	No power: Check mains socket is on, check fuse in boiler plug, check plug and socket on boiler left hand face is fully engaged.
Keys do not respond when touched	Screen is dirty or wet: clean the screen with a damp soapy non abrasive cloth then dry. Ensure hands are dry when pressing keys. Also please make sure clear film is removed (if applicable).
Error “E” code displayed on screen	E3 – no water in boiler, fill / flush with water, message will self clear E5, E6, E7, E8, E9 for service use only – contact service number on top of unit.

1.3.2 Water temperature:



Issue description:	Possible issue & solutions:
Water temperature is lower or higher than expected.	Press the “+” & “-” keys and check the target temperature is as expected.
Water temperature is lower than expected.	The boiler has not started its reheating cycle after its last use: the boiler shows “READY” because only a small amount of water has been used and it takes a few minutes for the boiler temperature to equalise and then start its reheat cycle. The boiler has not completed its reheating cycle after its last use: the “HEATING” indicator is still showing during use.
Water temperature is lower or higher than expected.	The boiler internal may be calcified and may need descaling.
Water temperature is lower than expected.	There has been a power cut (interruption to the power supply) the boiler automatically turns back on into standby mode. press and hold  for 1.5 seconds to revert to normal mode. Follow “Periods of non-use” (1.1.5) guide to ensure water is heated.
Water temperature is lower than expected.	The centre spout tube in the tap may be disconnected from the aerator, see “descaling-aerator” section for more detail.

1.3.3 Water dripping from the spout end when the handle is in the off position:



Issue description:	Possible issue & solutions:
Water is dripping (continuously from the centre channel of the spout end aerator).	<p>The hot water on/off valve is leaking, to confirm the fault:</p> <ol style="list-style-type: none"> 1) Turn the boiler into standby mode, press and hold the  key for 1.5 seconds to activate. 2) Turn the 98°C tap handle off fully. 3) If the water continues to continuously drip or leak the boiling water valve needs to be replaced.
Water is dripping (continuously from the outer channel of the spout end aerator).	<p>The standard hot and or cold water on/off valve is leaking, to confirm the fault:</p> <ol style="list-style-type: none"> 1) Isolate the hot and or cold water supplies leading to the tap in turn, to see if the dripping stops or not.
Water is dripping (intermittently from the centre channel of the spout end aerator). Most typically whilst the boiler is reheating	<p>The expansion chamber in the boiler may be full:</p> <ol style="list-style-type: none"> 1) Turn the boiler target temperature to 75° 2) Turn the 98°C tap handle on fully, run for at least 2 litres continuously to self-empty the expansion chamber. <p>The incoming cold water pressure is less than 1.5 bar, at low pressures the expansion chamber will not self empty correctly, use a pressure gauge or use the tap specific flow test on cold water only to confirm the incoming pressure.</p>
Water is dripping (intermittently from the centre or outer channel of the spout end aerator typically shortly after each use).	<p>This is water retained within the spout falling due to gravity and is normal for any tap.</p>

1.3.4 Water flow rate / stream quality:

Issue description:	Possible issue & solutions:
<p>98°C Water flow rate is slower than expected. Note: the typical flow rate is between approximately between 1 and 2 litres per minute depending on your incoming cold water pressure and tap type, refer to the tap specification sheet for more detail.</p>	<p>The boiler could be calcified: follow the boiler descale procedure in this manual.</p> <p>Your incoming cold water pressure could be too low: test your incoming cold water pressure and compare it to the minimum required pressure.</p> <p>Your filter cartridge could be partly blocked with debris: connect the blue flexible pipe from the filter inlet directly to the boiler (bypass the filter) to confirm, if needed replace the filter.</p> <p>Your boiler inlet could be partly blocked with debris: with the water isolated remove the blue inlet wingnut (G) and inspect the meshed inlet seal (H) underneath, clean if required.</p> <p>The aerator on the tap end could be partly blocked with debris or calcified: follow the aerator descale procedure in this manual.</p>
98°C water does not stop the instant the 98°C handle is turned off.	<p>It is normal for a short delay after the handle is turned off for water to stop flow as the pressure remaining in the filter and boiler tank equalise.</p>

<p>98°C water does not start the instant the 98°C handle is turned on.</p>	<p>It is normal for a short delay after the handle is turned on for water to start flowing as the tap empties partly after each use.</p>
<p> Water splashes sideways or irregularly from the spout end</p>	<p>The spout aerator may be blocked or calcified, see “descaling-aerator” section for more detail.</p>
<p> Water flow rate is faster than expected or is splashing</p>	<p>The aerator on the tap could be partly blocked with debris or calcified: follow the aerator descale procedure in this manual.</p> <p>Your incoming cold water pressure could be too high: test your incoming cold water pressure and compare it to the recommended and maximum required pressures, install a pressure reducing valve to your cold water mains supply if needed.</p> <p>Follow the “Using the product safely” section of this manual: turn on the 98°C water handle only partly during use.</p>

1.3.5 Leaking from the boiler

Issue description:	Possible issue & solutions:
<p> Water is leaking from the boiler.</p>	<p>The boiler could be leaking from between the inlet adaptor and the boiler inlet: Remove the inlet adaptor (G) and check that the internal flat rubber seal is present internally and that rubber meshed seal (H) is also present, undamaged and seated correctly. When reconnecting the inlet adaptor (G) do not overtighten.</p> <p>The boiler could be leaking from between the outlet adaptor and the boiler outlet: Remove the outlet adaptor (J) and check that “flat” rubber seal (I) is present, undamaged and seated correctly. When reconnecting the adaptor (J) do not overtighten.</p>
<p> The silicone high temperature hose (K) “blows” off the outlet wingnut adaptor (J) or 3/8” male tap connector (L) when the tap boiled water handle is turned on.</p>	<p>The steel braided flexible hoses attached to the tap have been installed incorrectly: To confirm disconnect the silicone outlet tube (K) outlet wingnut adaptor (J), turn the 98° tap handle slowly part on. If cold water comes out of the silicone high temperature hose (K), the installation is incorrect, turn off the boiler power, the installation must be checked and corrected before further use.</p> <p>The silicone hose from the boiler or the high temperature braided steel flexible hose in the tap is kinked: check the hose for kinks and or damage, remove and reattach without any kinks.</p>

 **Note: If your experience an issue that is not listed here or corrected permanently by the following the troubleshooting guide, please follow the steps below:**

1. Switch the boiler off.
2. Isolate the mains water to the product
3. Contact the service number on top of the boiler

 **Other than as described in the maintenance, care, descaling, troubleshooting and cleaning sections of this user guide, this appliance must not be opened, serviced or repaired by anyone other than an authorised service agent.**

1.4 Warranty terms and conditions:

If you believe your product has developed a fault, firstly isolate the product from the mains power and water then please review the troubleshooting section of this guide, should this not resolve your issue then please contact the service agent (details shown on the top of the boiler). Do not wait to do this once you suspect a fault. Please have the model and serial numbers to hand when calling.

Your PROBOIL boiler system is guaranteed against defective materials and workmanship for 2 years after installation provided the installation is registered, the system has been installed domestically and used and installed strictly in accordance with the instructions supplied. That any failure is not due to accident, misuse, abuse, unsuitable water conditions, failure to service or maintain or replace consumable items on schedule, alteration, modification or repair by any party not expressly nominated by the manufacturer. In the event of any claim the manufacturer or service agent must be given the opportunity to assess the product institute as part of our claims process.

No other warranties, express or implied, are made, including merchantability or fitness for a particular purpose. Under no circumstances shall the manufacturer be liable for any loss or damage arising from the purchase, use or inability to use this product, or for any special, indirect, incidental or consequential damages. No liability is accepted for consequential damage to other household fixtures, fittings or furnishings arising from this claim, even if attached to the product. No installer, dealer, agent or employee of PROBOIL has the authority to modify the obligations or limitations of this warranty. Where any additional service or maintenance contract is subscribed to and is valid then these terms and conditions may be superseded and or improved. You should check for any appropriate additional cover that it may offer to these standard terms.

The manufacturer may, where appropriate, provide replacement parts for your product or repair or replace all or part of your product at their discretion under this warranty. Any associated or ancillary costs to be incurred by you as a result of replacement of the product or parts under this guarantee, must in all cases be previously approved by the manufacturer. This guarantee is in addition to and does not affect your statutory rights.

No warranty applies to the filter cartridge life, this is affected by the setup, varying water quality and personal pattern of usage and as such the combination of these variables is untestable. The information provided on filter life is from independent laboratory testing and as such is provided in good faith. **Any product warranty is invalidated if the recommended filter cartridge or descaling solutions are not used as described for example if the filter is set up incorrectly, not replaced as required according to your personal water conditions in order to protect the PROBOIL working life and efficiency or the product is not descaled and cleaned.** No warranty applies to wear and tear expected to occur during the normal course of use, including without limitation, cosmetic rust, scratches, dents or comparable and reasonably expected losses or damages.

These installation guidelines have been prepared for your direction and you must exercise due care at all times. We do not accept responsibility for problems that may occur through improper installation. Whilst assembling the product take care not to accidentally loosen any screwed or fixed assemblies.

Once the installation is completed as instructed, the installer should check carefully for any leaks. Periodically you should visually check for any slower leaks also for prudence, if this is impractical, due to the nature of the usage or property occupation, we suggest installing a standard available market leak detector or preventer.

It is the responsibility of the installer to ensure that your product is fitted in accordance with Local Water Byelaws and in a professional and workmanlike manner.

Errors and omissions excepted. Should you find any errors in this guide please inform us to help continually improve any future revisions of our literature.

2 PROBOIL.2X installer guide

2.1 About the PROBOIL.2X water heater:

2.1.1 Important technical data:

Boiler:

Measure:	Comments:
Model	PROBOIL.2X (AQ5001353)
Boiler type	Vented (unpressurised) displacement system
Unit dimensions	325x188x188mm, with connectors attached, without pipes attached
Overall weight	6.5 kg (Apx. when full)
Ambient operating temperature	+5°C to +40°C (indoor use heated space only)
Minimum cold input pressure	Typically 1 bar (minimum usable), 1.5 bar (recommended). Varies by tap model, values shown are assuming a minimum acceptable flow rate of 1 litre per minute.
Maximum cold input pressure	5.5 bar, if incoming cold water pressure is above this value than a pressure reducing valve must be installed.
Boiling tank capacity	2.1 Litres +/- 5%
Typical usable volume	1.4 Litres, depending on temperature selection
Maximum Chlorine value for incoming water	100mg/l
Tank material	Stainless steel (304)
Selectable in tank temperatures	98° Maximum with adjustable heating point adjustment on screen (75, 85, 90, 95, 96, 97- 98°C range)
Heat up time	From 20°C (full and cold tank) to 98°C displayed in Apx. 9 minutes 1 litre usage recovery, average time Apx. 11 minutes 2 litre usage recovery, approximate time Apx. 7 minutes (up to 60 UK cups per hour dependant on usage pattern)
Thermal loss	Varies according to tap model, environmental and usage conditions, Apx. 4°C. loss from tank to spout exit
Safety devices	<ul style="list-style-type: none">- vented (unpressurised) tank- minimum water level float switch to prevent dry heating- digital thermal monitoring and control- digital self-diagnostic control- one shot dry burn 120°C thermal fuse (non-resettable)- blow off connection for accidental blockage protection
Supply voltage range	AC 220-240V (50Hz)
Max. Power usage (element on)	1.5kW at 240V AC
Power usage Standby (screen off)	<0.5W
Power usage (keep warm at 98°C)	0.025kW, depending on ambient temperature, power on, no water usage.
Power usage (reboil 1 litre at 98°C)	1.5kW (based on single 1 litre dispense of 98°C)
Power lead	1.4M (cable), 3 pin UK plug (13A), IEC connector, do not extend or replace.



This symbol on the product(s) and / or accompanying documents means that used electrical and electronic products should not be mixed with general household waste. For proper treatment, recovery and recycling, please take this product(s) to designated collection points where it will be accepted free of charge. Alternatively, in some countries you may be able to return your products to your local retailer upon purchase of an equivalent new product. Disposing of this product correctly will help save valuable resources and prevent any potential negative effects on human health and the environment, which could otherwise arise from inappropriate waste handling. Please contact your local authority for further details of your nearest designated collection point.

This product is manufactured in accordance with:

The LVD Directive 2014/35/EU

The RoHS Directive 2011/65/EU and its amendment directives 2015/863/EU

The EMC Directive 2014/30/EU

Our current declaration of performance can be found at www.proboil.uk

Filter cartridge:







Physical dimensions	68Ø x 285mm, filter only.
Filter weight	When empty: 0.56kg
Minimum cold water pressure	0.5 Bar (filtered cold water application without boiler)
Maximum cold water pressure	5.5 bar
Capacity rating	1000 L (Hardness only capacity) at a temporary hardness of 150ppm and a flow rate of 2L/Min.
Filter life	Once installed recommended replacement schedule is 6 Months or use of capacity (whichever is sooner) filter life varies by location and usage pattern. The filter life indicator bar and expiration notification beep will remind the customer to replace the filter.
Water temperature range	1-23°C (incoming water)
Suitable for water types	Use only on a municipally treated water supply, or one of an acceptable bacteriological quality.
Filter mesh rating	5 micron nominal rating
Primary filter contents	Granular activated carbon, Ion exchange resin.

Tap / dispenser:

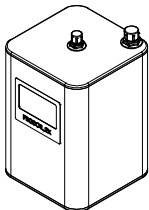
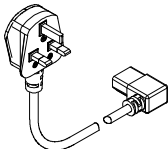
Varies by model installed, please refer to instructions supplied separately.

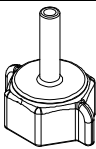
2.1.2 Parts and contents:

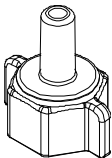
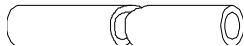
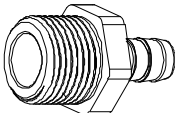
This carton will contain the following parts, please check all are present and free from transportation damage before commencing installation.

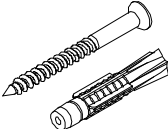
Qty.	Description	Key Number	Spares part code	Drawing / image
1	PROBOIL.2X boiler unit Complete with sealing caps	A	N/A	
1	Mains power cable	D	ASPT1180-D1	
1	¼" flexible blue inlet pipe (1.5M)	E	ASPT1180-E1	
1	¼" Inlet pushfit connector	F	ASPT1180-F1	
1	½" Inlet "wingnut" connector With integral "flat" rubber seal	G	ASPT1180-G1	
1	Inlet meshed filter seal	H	ASPT1180-H1	
1	Outlet rubber seal	I	ASPT1180-I1	
1	3/8" Outlet "wingnut" connector	J	ASPT1180-J1	
1	Silicone outlet tube (0.75M)	K	ASPT1180-K1	
1	8mm barbed stem x 3/8" male tap connector	L	ASPT1180-L1	
1	Installation and user guide (boiler only, tap supplied separately) registration card	N/A	download from www.proboil.co.uk	
2	Installation screws and plugs	M & N	ASPT1180-M1	

2.2 Installation:

2.2.1 Installation preparation

Preparing yourself to install the product is an important part of the installation and will help you overall to improve the quality and speed of the installation of this product.

- 1) Turn off the hot and cold domestic water supplies or isolate the both feeds with local isolation (service) valves.
- 2) Remove any existing mixer tap from the tap hole and clean away any dirt or debris.
- 3) Check the tap hole diameter is 35mm \emptyset and no thicker than 40mm (unless specified differently within the model specific tap instructions).
- 4) Roughly lay out the approximate arrangement of the boiler, tap and filter within the cabinet to check for any required alterations before progressing, if physically installing the product will be a problem, do not progress the installation without rectifying it first.
- 5) Check the tap hole is no further than 1 meter away from the planned location of the boiler outlet.
- 6) Check the cold water mains pressure is between the accepted minimum and maximum range listed within the “about the product” section.
- 7) Check the hot pressure is between the accepted minimum and maximum range listed on the tap installation instructions.
- 8) Flush both the domestic hot and cold supply feeds to a bucket or the sink drain.
- 9) Check the mains power socket is switched, 13A, supports 1.5kW or greater, is earthed, not located near water connections, is within 1.4 meters of the boiler location protected by RCD and permanently accessible.

Now you have completed the preparation stage of the installation, complete this checklist as an aid to yourself and your customer, complete or circle the appropriate answers below, if any questions are answered as “no” then you must rectify this before commencing the installation.

About the product:

Date of installation	/ /	
Serial number (taken from top of boiler or data plate)		
All parts are present, correct and undamaged	YES	NO

Install location:

There is enough physical space to install the boiler and filter cartridge within the cabinet	YES	NO
The tap hole is no further than 1 meter away from the planned location of the boiler outlet	YES	NO
The tap hole is 35mm Ø and the sink or worktop is not thicker than 40mm	YES	NO

Electrical:

The power supply will support 1.5kW at 240V AC	YES	NO
The supply socket is earthed	YES	NO
The power socket is permanently accessible by the customer	YES	NO
The power socket is 13A and switched	YES	NO
The power socket is within 1.4 meters of the boiler installation location	YES	NO
The power socket is not directly below or near any water connections	YES	NO
The electrical supply is attached to a modern consumer unit with RCD protection else we recommend installing a local RCD protection device in the socket being used by the appliance.	YES	NO

Plumbing:

Cold water mains pressure is 1.5-5.5 bar	Gauge reading (bar):	
Hot water mains pressure is suitable for the specific tap model to be installed (see tap installation instructions)	Gauge reading (bar):	
A domestic hot and cold supply is available with separate isolation valves on both feed pipes	YES	NO
The cold mains water is supplied known safe source of drinking water	YES	NO
The domestic hot and cold supply is thoroughly flushed before installation	YES	NO

2.2.2 Install the tap

 **Installation of the tap will vary from model to model, you must now refer to the separate installation guide supplied with the tap or dispenser at this time.**

- 1) Install the tap as per the model specific guidelines supplied with each tap connect the domestic cold (and hot if applicable) water inputs to the tap.
- 2) Check you have the right hoses attached to the right inlets and outlets of the tap, you can quickly do this by very slowly part opening the operating handle(s) to an on position and checking for output being out of the expected hose into a bucket or similar.

 if when you turn the 98°C handle on, water then comes out of the high temperature inlet tap hose, the hoses are not installed correctly, this must be corrected before continuing.

- 3) If you are installing a tap **without a filtered cold water** dispense option you should have 2 hoses without any connection:
 - a. A outlet hose ending with a ¼" pushfit connection, this will be the cold water output to the filter cartridge inlet and then onward to the boiler ¼" hose end.
 - b. A inlet hose with a 3/8" female threaded connection, this will be the taps hot water input from the boiler output via a series of connections.
- 4) If you are installing a tap **with a filtered cold water** dispense option you should have 3 hoses without any connection:
 - a. Two hoses ending with a ¼" pushfit connection, these will either be:
 - i. The filtered cold water input from the filter cartridge output to the tap.
 - ii. The filtered cold water output from the tap to the boiler.

 **It is important these two hoses with ¼" pushfit connections are not inverted, refer to the tap instructions and double check and quickly mark which hose is which to avoid a later problem.**

- b. A inlet hose with a 3/8" female threaded connection, this will be the taps hot water input from the boiler output via a series of connections.

2.2.3 Install the filter

The filter is supplied within the tap package and must be installed after the tap or dispenser.

Again, the instructions for installing the filter vary by tap model so you should refer to these separately now.

 Always try to leave a little excess length (apx. 200mm) on each of the ¼” blue hoses coming to and from the filter cartridge, it can always be shorted later, the excess length will make it easier for your customer to remove the filter cartridge from its clip when changing it.

 Don't locate the filter cartridge above any electrical appliance or socket, when the filter is exchanged some of the water contained inside it may fall on it.

 install the filter in a location that is easily accessible for your customer to reach into the cabinet and exchange it, avoid the rear of the cabinet if possible.

 Always write the installation date on the filter label in permanent pen (and leave the label on view) it will help your customer as a visual reminder to exchange the filter on schedule.

 **Install the filter as near vertical as possible (never horizontally)** a small angle is not problematic if space or access is limited within the cabinet.

 Always ensure the input and output from the filter to and from the tap and boiler **respect the direction of flow marked on the filter.**

 It is normal for new filters to lose a small amount of loose carbon when first used and will dissipate with flushing, whilst harmless to consume if the carbon particles are not flushed prior to connection to the boiler they make partly block the boiler and reduce the flow rate. **You must flush the filter for at least 2 litres with cold water or until the water become clear (without black carbon particles) into a bucket or similar before connecting the filter output to the boiler inlet.**

2.2.4 Install the boiler

i The boiler should be the last section of the product to install, you should already have the tap and filter installed and the cold filtered (1/4" blue tube) water and hot water hose connector to the tap free and ready to connect.

⚠ WARNING: You must not solely use the overall assembly diagram as a guide to installation, we are not liable for any safety or performance issues as a result of not following the step by step installation guide in this guide with due care.

Key	Description	Drawing
A	PROBOIL.2X boiler unit	
B	1/2" male boiler inlet (with internal check valve)	
C	3/8" male boiler outlet	
D	mains power cable	
E	1/4" flexible blue inlet pipe	
F	1/4" x 1/4" inlet pushfit connector	
G	1/2" blue Inlet "wingnut" connector (with integral "flat" rubber seal)	
H	inlet connector meshed filter seal	
I	Outlet connector rubber seal	
J	3/8" red Outlet "wingnut" connector	
K	Silicone outlet tube (0.75M)	
L	8mm barbed stem x 3/8" male tap connector	
M	2 x Wall fixing screws	
N	2 x Wall fixing plugs	
O	1/2" inlet transport cap	
P	3/8" outlet transport cap	
Q	3/8" female flexible (braided/silicone) hose tap connector assembly and fibre seal (supplied with tap)	

1. Roughly position the boiler **(A)** into its final installation location.

Check there is sufficient length on the pipes **(E & K)** to and from the boiler to make connections.

Check the power cable **(D)** will reach the power outlet socket.

Check the boiler is accessible to your customer so they can easily disconnect and remove the boiler for maintenance.

When you are confident with the boiler location, mark it with a pencil then continue.

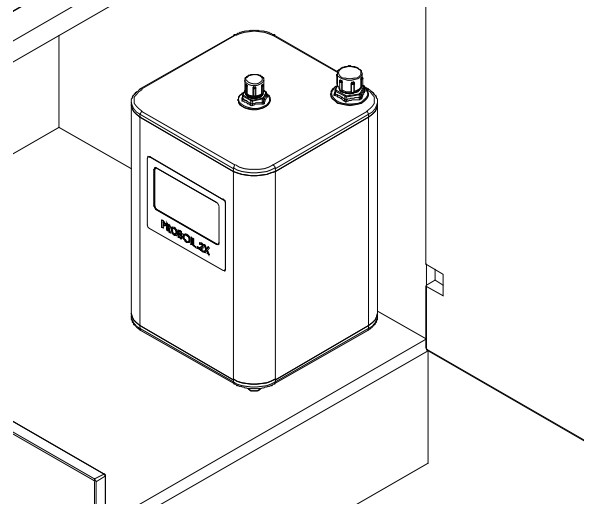

2. Unscrew the transport caps **(O & P)** from the boiler inlet and outlet **(B & C)**.

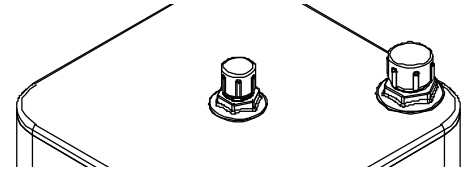

3. Turn the boiler upside down and tip any residual testing water inside the tank into a sink.

4. Mark on the cabinet wall the fixing hole centres.

Ensure the hole centres are level horizontally, we suggest centres of **90mm** at a **minimum** height of **245mm** from floor level in the cabinet.

⚠ The boiler must be fixed to secure point to prevent accidental tipping of the boiler unit. The unit weighs approximately 6.5 kg when filled with water so the wall and fixing used must be appropriate.

Using the screws **(M)** and if needed plugs **(N)** provided (or similar if not suitable for your surface material) drill and screw the fixings to the marked hole centres. The screw head will need to be about 5mm from flush to allow you to mount the boiler.

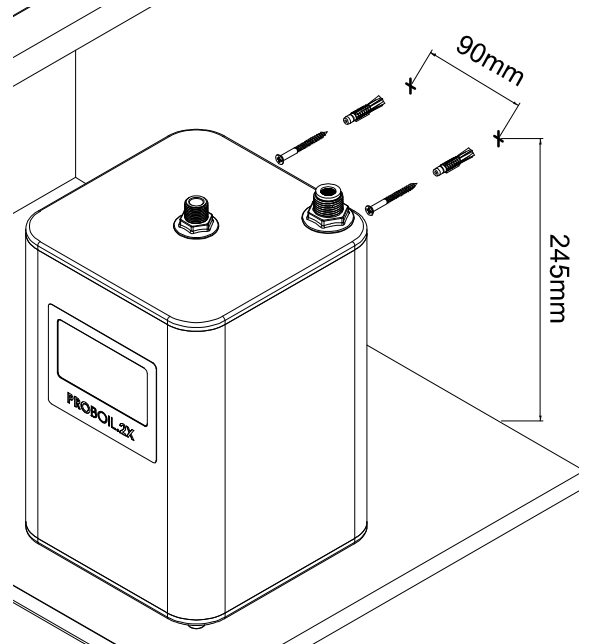

5. Insert the $\frac{1}{2}$ " rubber meshed seal **(H)** into the $\frac{1}{2}$ " boiler inlet **(B)**, ensure the orientation of the seal is as shown.
6. Screw the $\frac{1}{2}$ " blue wingnut inlet connector with integral/ internal "flat" rubber seal **(G)** hand tight (**do not use a spanner or overtighten as the rubber seals may distort or be damaged**) on to the boiler $\frac{1}{2}$ " inlet male **(B)**.
7. Push fully and firmly the $\frac{1}{4}$ " x $\frac{1}{4}$ " pushfit connector **(F)** onto the $\frac{1}{2}$ " blue wingnut inlet connector **(G)**.

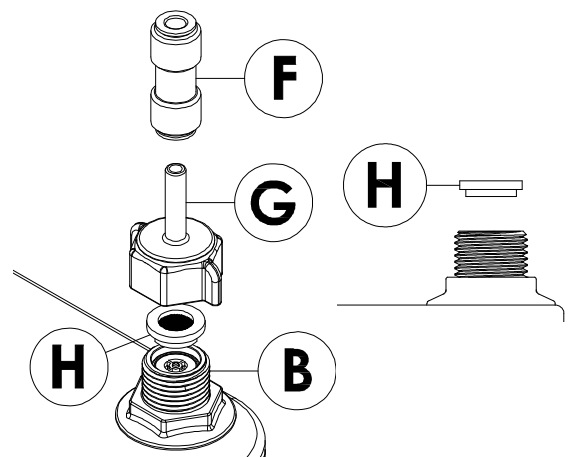

8. Check that the red 3/8" x 8mm boiler outlet connector (J) has preinserted internally the 3/8" rubber seal (I), **an additional seal is supplied, ensure to use only 1 x 3/8" rubber seal in this connection.**
9. Screw the red 3/8" x 8mm boiler outlet connector (J) hand tight (**do not use a spanner or overtighten as the rubber seal may distort or be damaged**) on to the boiler 3/8" male outlet (C).

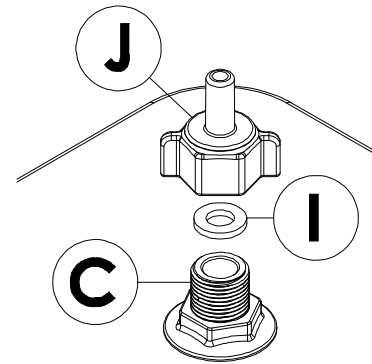

10. Plug the power cable (D) securely into the socket on the left-hand side of the boiler (A).

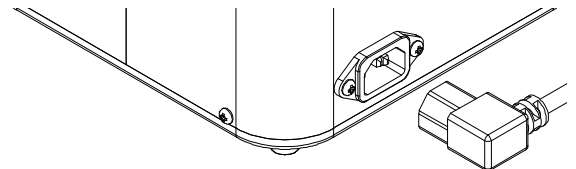

11. Hook the boiler keyhole slots onto its wall fixing screws (M) and check it is secure.
12. Take the 1/4" blue flexible pipe (E) that carries the cold filtered water output from the filter and rough out the minimum amount of pipe needed to connect to the 1/4" x 1/4" pushfit connector (F) found on the boiler inlet.

Mark the desired minimum pipe length with a permanent pen.

 We recommend cutting the 1/4" blue flexible pipe (E) at least 200mm longer than the required minimum pipe length to allow the boiler to be serviced more easily by your customer, otherwise remove unnecessary/unneeded pipe length to keep the installation tidy.

Cut the 1/4" blue flexible pipe (E) to length cleanly and squarely using a snip tool, sharp craft blade or similar.

13. Push the 1/4" blue flexible pipe (E) fully and firmly into the 1/4" x 1/4" pushfit connector (F)
14. Firmly and fully push the silicone outlet tube (K) over the 8mm barbed stem x 3/8" male tap connector (L).
15. Screw the 8mm barbed stem x 3/8" male tap connector (L) into the 3/8" female flexible 110°C hose tap connector (Q), **you must ensure to use 3/8" the fibre seal (Q) (supplied separately with the tap) is in this connection.**

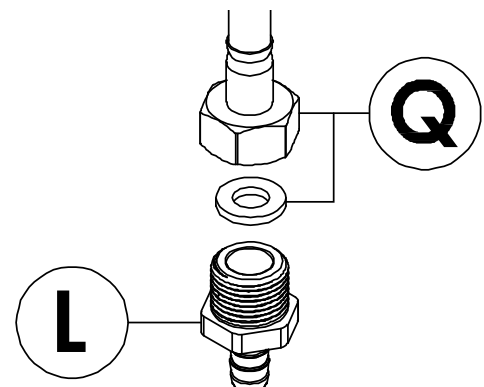
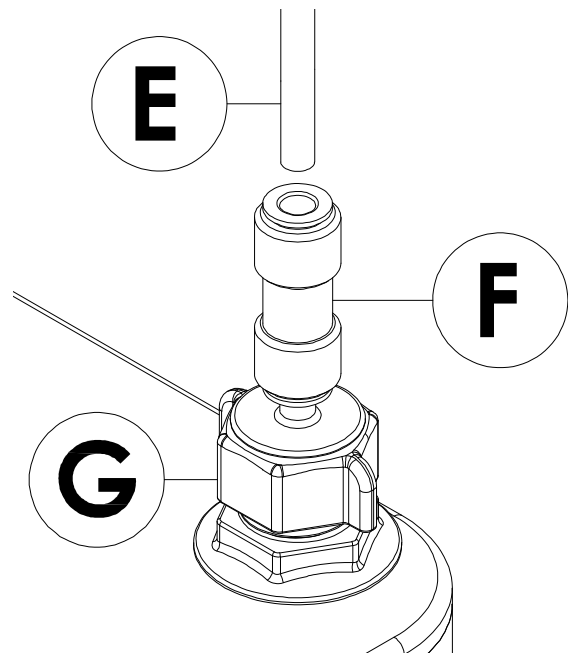

 **WARNING:** You must not directly connect the tap hose (Q) directly to the boiler output (C). You must always use output adaptor (J) and silicone hose (K) to connect the tap.

16. Take the silicone outlet tube (K) that carries the 98°C water from the boiler to the tap and rough out the minimum amount of pipe needed to red 3/8" x 8mm boiler outlet connector (J) found on the boiler outlet.

Mark the desired minimum pipe length with a permanent pen.



We recommend cutting the silicone outlet tube (K) at least 50mm longer than the minimum mark. According to the drawings (right) the silicone outlet tube (K) must:

- Not** be excessively long, creating a "dead leg".
- Not** be too short (pipe is stretched).
- Not** be twisted or kinked when attached (creating a blockage).

Cut the silicone outlet tube (K) to length cleanly and squarely using a sharp craft blade or scissors or similar.

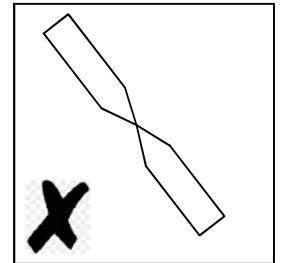
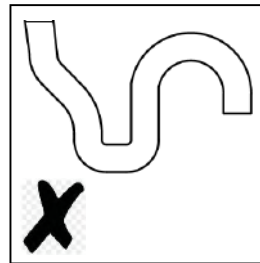
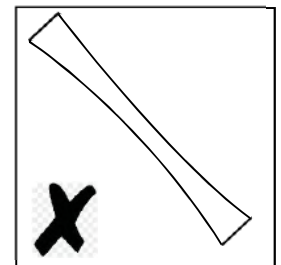
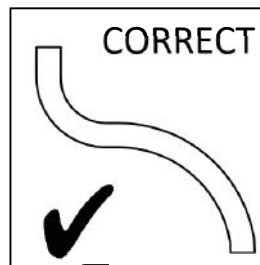

17. Firmly and fully push the silicone outlet tube (K) onto the red 3/8" x 8mm boiler outlet connector (J)



Ensure the red 3/8" x 8mm boiler outlet connector (J) stem is clean of dirt or grease with a clean cloth, wetting the 8mm outlet stem with clean water will ease attaching the silicone outlet tube (K)



Under no circumstance should you modify / permanently connect or tube (K) with outlet connector (J), this connection is designed to break in the event of a fault condition, blockage or installation error to prevent over pressurisation within the tank.

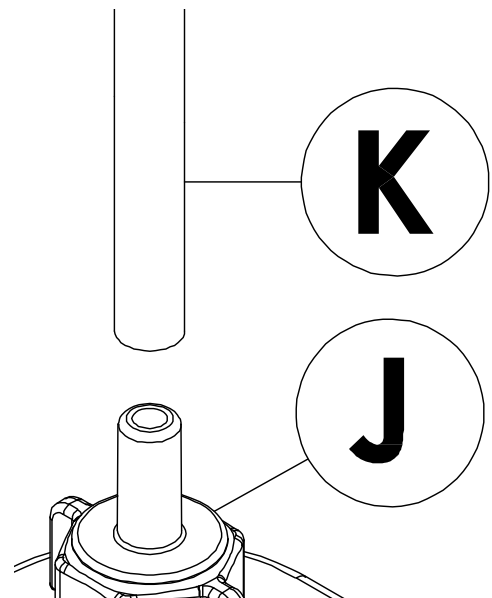

18. Your boiler is now plumbed to the tap and the filter, plug the power cord into the mains outlet **but do not switch on the mains power outlet at this time.**

19. Ensure any isolation valves to the tap and filter are now fully opened. Now turn on (open) fully the 98°C water handle. Water will now begin to purge air through the entire system.



During the purging of air in the system it is normal for the tap to spit, continue until the stream from the centre channel of the tap aerator is continuous. Depending on the incoming water pressure it will take apx. 2-3 minutes to fill the tank and purge the air.

2.2.5 Commissioning and testing

You have finished the installation, now please take a few moments to go through the commissioning and testing process, this will ensure the product is working correctly, safely and your customer's satisfaction.

 **WARNING:** You must not skip this section, we are not liable for any safety or performance issues as a result of not following the step by step installation guide with due care, **DO NOT TURN ON THE BOILER UNTIL FULLY FLUSHED.**

1. Turn on (open) fully the 98°C water handle.

 After the air is purged from the system you **must** continue to run cold water through the tank for a further minimum of a 5 minutes to flush it.



During the flushing period check all connections made during the installation carefully for leaks.

2. After the flushing period is completed turn off (close) fully the 98°C water handle.
3. Press and hold the “” key on the boiler screen, it should switch to the standard screen and not display any error “E” codes.
4. Press the “+” key on the boiler screen and set the target temperature to 98°C.
The boiler will take approximately **9 minutes** to reach its “**READY**” state. Use this time to complete the checklist items in this guide.



The few first times the boiler fills and heats from a “fully cold” state it is normal that the tap may drip slightly from the spout centre channel during heating, this will self adjust with use.

5. After the boiler reaches its “**READY**” state repeat steps 1-2.
6. With all tap handles in the closed position again check the installation carefully again for any leaks.

Please complete the commissioning checklist, if any questions are answered as no or below the stated acceptable threshold then you must rectify this before concluding:

Commissioning checklist:

98°C water only flow rate is greater than 1 litre per minute	Tested value (litres per minute):	
Domestic hot water only (if applicable to tap model) flow rate is greater than 2.5 litres per minute	Tested value (litres per minute):	
Domestic cold water only (if applicable to tap model) flow rate is greater than 2.5 litres per minute	Tested value (litres per minute):	
Cold filtered only (if applicable to tap model) flow rate is greater than 1 litre per minute	Tested value (litres per minute):	
The boiler turns on and heats water without any reported errors on screen	YES	NO
The boiler has been flushed for 5 minutes, then boiled and flushed entirely at least twice	YES	NO
The installation and all connections have been checked for any leaks	YES	NO
You have demonstrated to the customer how to isolate water and power if needed	YES	NO
All documentation supplied has been left for or handed over to the customer	YES	NO
All plumbing connections have been adjusted to length to avoid unnecessary dead legs and prevent accidental snagging	YES	NO
The boiler is fixed to the cabinet wall to avoid accidental tipping	YES	NO
Check valves have been installed as required by local law	YES	NO