

Mono Mixer Installation and Maintenance

PLEASE READ THIS INSTRUCTION GUIDE FULLY PRIOR TO COMMENCING ANY PART OF THE INSTALLATION

PRE-INSTALLATION

Installation should only be carried out by a qualified installer
 Always check pressure compatibility, check website for min/max pressure of product
 Pressures to hot and cold supplies should be balanced for optimum performance
 All parts of the installation must comply with the relevant Water Regulation requirements
 Isolation valves should be fitted to both supply pipes as part of the installation
 Always flush pipework prior to connection to the mixer

TURN OFF WATER SUPPLY BEFORE COMMENCING INSTALLATION OF NEW MIXER



GUARANTEE

Check website for individual product guarantee's
 Moving parts of the product ie cartridge are covered by a 12 month guarantee
 See our website for T & C's
 Your guarantee can be invalid if the pre-installation checks are not carried out, installation is not carried out as per this guide and correct maintenance instructions are not followed.

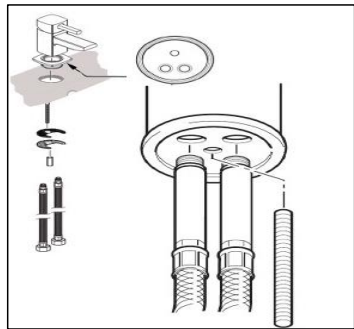

INSTALLATION (HOT supply to left / COLD supply to right)

- 1) Fit the base plate to the mixer if one is supplied with your product
- 2) Place base washer if supplied between the base plate and the basin/top
- 3) Screw the fixing bars into the mixer and tighten
- 4) If this is the case, connect one tail, feed this and the fixing bars through the hole
- 5) From the underside feed the second tail through the hole and connect to the mixer
- 6) Tighten both tails (Hand tight - DO NOT use a spanner or grips to tighten/ DO NOT use PTFE on the tail threads)
- 7) Place rubber horse shoe and metal horse shoe around the tails and fixing bars
- 8) Push to underside of basin and secure using fixing nut
- 9) Position mixer correctly and tighten nuts to secure
- 10) Commissioning should then take place to ensure correct function and check for leaks

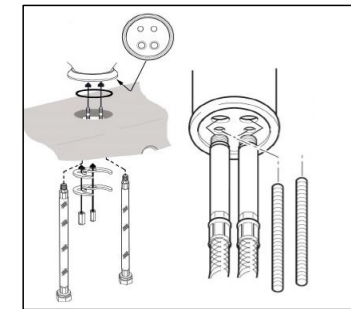

IMPORTANT

When installing the tails, this should be done in such a way to prevent kinks, flat spots and excessive bends, which will affect performance and can potentially cause long term damage and leaks - grips and/or a spanner should not be used to tighten into the mixer
 No bend in the tail should be less than 25mm radius

CORRECT GENTLE BENDS ✓

INCORRECT ANGLES/KINKED ✗

INCORRECT EXCESSIVE BENDS ✗

INCORRECT KINKED/FLAT ✗

CLEANING

To maintain your product cleaning should be carried out on a regular basis.

No harsh chemicals should come into contact with any part of the product, no abrasive materials can be used to maintain the surface, use a damp cloth to wipe and dry cloth to polish.

Any splashes or spills must be rinsed and wiped dry immediately.

Use of any abrasives or chemicals will invalidate your guarantee



MIXER ISSUE

Mixer drips after being turned off

Poor flow

Water not mixing

See Next Page For Maintenance Advice Regarding Removal Of Valves And Cartridges

DIAGNOSIS

Draining / Due to the design of some mixer spouts, water will be held and drip until emptied.

Debris inside cartridge or valve / Remove cartridge or valve and flush under running water whilst turning the spindle.

Insufficient water pressure / Increase water pressure possibly installing a pump.
 System pressure should have been confirmed as meeting minimum requirement pre-installation.

Blockage / Check water is reaching the mixer, check cartridge, mixer tails and supply pipes.
 Isolation valves not fully opened .

Hot and Cold supplies not balanced / Increase or decrease pressures to balance.
 (Always maintain the minimum pressure requirement)

Blockage / Check water is reaching the mixer, check cartridge, mixer tails and supply pipes.

PLEASE READ THIS INSTRUCTION GUIDE FULLY PRIOR TO COMMENCING ANY PART OF THE INSTALLATION

POST-INSTALLATION

To Remove Cartridge

TURN OFF WATER SUPPLY TO MIXER

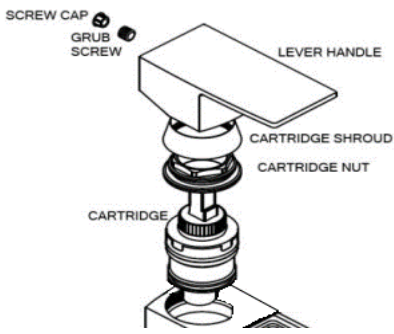

- > Remove screw cap cover
(This could be at front or back of handle)
- > Loosen grub screw using hex key
- > Pull handle from mixer
- > Unscrew cartridge shroud
- > Using a spanner remove cartridge nut
- > Pull cartridge from mixer
- > Carry out maintenance
- > Replace cartridge ensuring to locate pins on underside of cartridge with holes inside mixer
- > Replace all components
(Do not overtighten cartridge nut)

Design may vary from that shown

POST-INSTALLATION

To Remove Valve

TURN OFF WATER SUPPLY TO MIXER

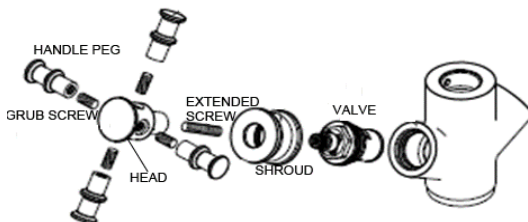

- > Unscrew all handle pegs
- > Remove grub screws using hex key
- > Pull head section from mixer
- > Remove extended screw
- > Unscrew shroud
- > Using a spanner remove valve
- > Carry out maintenance
- > Replace valve and tighten
- > Replace all components

Design may vary from that shown

To Remove Valve

TURN OFF WATER SUPPLY TO MIXER

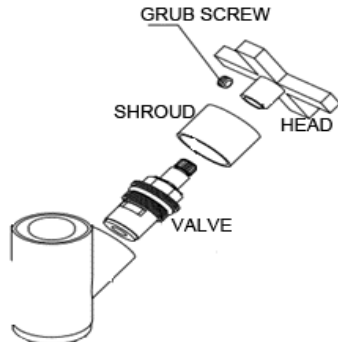

- > Remove grub screw using hex key
- > Pull handle from mixer
- > Unscrew shroud
- > Using a spanner remove valve
- > Carry out maintenance
- > Replace valve and tighten
- > Replace all components

Design may vary from that shown

To Remove Valve

TURN OFF WATER SUPPLY TO MIXER

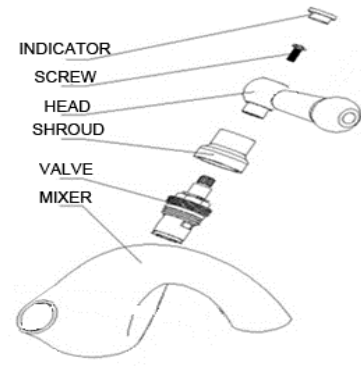

- > Remove H or C indicator
- > Using a screwdriver remove handle screw
- > Pull head from mixer
- > Unscrew shroud
- > Using a spanner remove valve
- > Carry out maintenance
- > Replace valve and tighten
- > Replace all components

Design may vary from that shown

Visit Our Website For Assistance

Please retain this document for future reference.

www.betterbathrooms.com